



# Electrofusion Installation Manual

Asmuss Plastic Systems Ltd and Plasson NZ work together to provide a high quality, comprehensive range of products, backed by strong Technical Support and Logistical Services.

Visit our website to find out more about the Plasson PE Electrofusion Range and the full suite of products we offer to the Civil Construction Industry.

**[www.asmussplasticsystems.co.nz](http://www.asmussplasticsystems.co.nz)**

**Other useful sites:**

[www.pewelding.co.nz](http://www.pewelding.co.nz)

[www.plasson.com](http://www.plasson.com)

**ALBANY**

Ph: (64) (9) 477 2320

Fx: (64) (9) 477 2328

[sales@plasticsystems.co.nz](mailto:sales@plasticsystems.co.nz)

34 Arrenway Drive, North Harbour

P.O. Box 100244, N.S.M.C

**MT WELLINGTON**

6 Gabador Place

Mt Wellington, Auckland

Ph:(64) (9) 573 0030

Fx: (64) (9) 573 0040

**SOCKBURN**

5 Paradyne Place, Sockburn

Christchurch

Ph: (64) (3) 348 4087

Fx: (64) (3) 343 0953

# ElectroFusion Installation Manual

It is important to read and understand all instructions before performing an ElectroFusion installation. Installations should be performed only by personnel that have been trained, qualified and certified for ElectroFusion welding.

The following Installation manual was written to give general introduction of the methods and tools used with Plasson's ElectroFusion fittings. All technical data, methods and techniques contained herein are given as broad and general information and should not be relied upon for specific applications. All data is given and accepted at user's risk and confirmation of its validity and stability in particular cases should be obtained independently. Plasson Ltd. makes no guarantee of results and assumes no obligation or liability in connection with the data contained herein.

# ElectroFusion



# Table of Contents

EF (ElectroFusion) General / 6

The advantages of Polyethylene / 7

Fitting Storage And Handling / 8

Installation Practice / 9

Pipe Compatibility / 10

Pipe Preparation / 12

Cutting The Pipe | Marking And Scraping | Re-Rounding | Clamping And Alignment

ElectroFusion Welding / 18

Fitting Data Input | Smartfuse System | Barcode | Manual | Post Weld Inspection | Cooling Time

EF Socket Fitting Installation Procedure / 25

Installation Highlights For Large Diameter Couplers / 26

EF Saddle Fitting Installation Procedure / 29

Tapping Instructions For Tapping Saddle / 30

EF Flex-Restraint Installation Procedure / 31

EF Large Diameter Saddle Installation Procedure / 32

Pressure Test Device For Plasson Large Bore Saddles / 34

Incorrect EF Jointing / 35

Product Batch Release Test Report / 37

Technical Specifications For Plasson EF Fittings / 38

# General

Plasson fittings are specifically designed for reliable, high performance pipe joining and long system life.

All Plasson products combine to form the latest state-of-the-art high performance pipe joining solution using high quality PE100 grades as the raw material. Plasson ElectroFusion fittings are part of a complete ElectroFusion smart system. The entire ElectroFusion process is executed and fully monitored by the computerized control box. Everything is computer-controlled ensuring safe, dependable connections. Plasson ElectroFusion fittings can be used with Plasson's computerized smart system control box or with standard barcode systems. Each Plasson ElectroFusion fitting comes complete with a barcode which contains a welding barcode, traceability barcode and further information such as the weld time, cool time etc. The line includes ElectroFusion fittings, tooling and control boxes.

Only authorized personnel are to perform ElectroFusion welds.

The following instructions are general guidelines and are not intended to replace the required practice as given by an authorized person.

The installation of the EF Fittings may have rules, regulations and requirements including those of the local installation company.

It is the installer's sole responsibility to inquire as to the existence of such rules, regulations and requirements and to implement them fully.

# The advantages of Polyethylene

- **Flexibility:**  
Polyethylene offers much more flexibility than the alternatives (metal, PVC, ABS, etc...). This means easier installation and the ability to use a trenchless technology for minimal environmental and public disruption.
- **Long service life:**  
The service life of fittings made of high density Polyethylene is estimated service life to be minimum 50 years.
- **Chemical resistance:**  
Polyethylene is highly resistant to most chemicals.
- **Corrosion resistance:**  
Unlike traditional metal products, Polyethylene does not rust, rot or corrode.
- **Light weighted:**  
Polyethylene has much lower weight than metal or concrete alternatives. This means easier handling and installation.
- **Eco friendly:**  
Polyethylene is known for its minimal impact on the environment.
- **Impact resistance:**  
Polyethylene exhibits an excellent impact resistance, even at low temperatures.
- **Smooth surface:**  
The smooth surface of the Polyethylene results in no deposits and low abrasion of the surface compared to alternative pipe and materials.
- **Weathering:**  
The Polyethylene used contains stabilizer pack which includes amongst other materials carbon black for long term UV protection.
- **Fusibility:**  
Polyethylene presents an excellent fusing ability. This feature is what makes Polyethylene the perfect material for welding connections.

# Fitting Storage & Handling

Fittings are packed in a protective plastic covering and should remain packed until ready for use. This plastic covering can be used to handle the fitting during installation in order to prevent contamination.

Fittings are to be stored in a warehouse in which the temperature should not exceed 50°C.

Never store fittings in direct sunlight. Plasson Black EF fittings contain a carbon black additive in order to protect from UV effects, however, unsuitable storage can adversely affect the fitting performance.

Before starting the installation process always check that the fitting has not been physically damaged during storage or handling.

If in doubt we recommend evaluation of the fittings by performing sample destructive test - this will enable to determine if surface degradation has occurred.



# Installation Practice

## Equipment check list

Using proper and dedicated tooling is essential for the success of the EF welding. It is always recommended to check that all required equipment is available prior to beginning the welding procedure.

Make sure all equipment that requires calibration is calibrated.

Equipment may vary to some extent depending on the product welded or the diameters dealt with, but should include the following:

### Pipe preparation

- Means of measuring the pipe (Pi tape, meter, etc)
- Pipe cutting equipment
- Marking pencil or pen
- Scraping tools
- Cleaning material, ensure wipes are saturated with alcohol (have not dried out)
- Re-rounding tools
- Pipe clamping tools

### Fusion equipment

- Power generator  
The generator should be appropriate for the job and capable of supplying the required power.
- ElectroFusion control box with correct leads, barcode reader (not on manual boxes) and sufficient output power.

# Pipe Compatibility

Plasson Fittings are weldable to PE80, PE100 and PEX\* pipes.  
Check that the pipe SDR is compatible with the Plasson fittings.  
For pipe SDR compatibility refer to Plasson literature or contact your local Plasson representative.

Pipe compatibility guidelines:

Plasson's ElectroFusion Fittings:

- Up to 75mm (inclusive) are Weldable to Pipes SDR  $\leq 11$
- Elbows and Tees of main diameter 40mm-75mm  $\leq 17$
- 90mm & Up are Weldable to Pipes SDR  $\leq 17$
- 63-75mm Tapping Saddles and Valves are suitable for SDR11

**Note:** for tapping SDR  $\leq 11$  pipes (size 63 and up), please consult your Plasson representative

\*Please consult your Plasson representative

LightFit:

- 90mm are Weldable to Pipes SDR  $\leq 26$
- 110mm - 800mm are Weldable to Pipes SDR  $\leq 33$

Wastewater Saddle:

- 200 mm & Up are Weldable to Pipes SDR  $\leq 26$

Wastewater Adjustable Elbow:

- 160 mm is Weldable to Pipes SDR  $\leq 17$

Measure the pipe external diameter toward the pipe end using a Pi tape.  
The pipe external diameter must be within the tolerances defined in International standards such as ISO 4437-2, AS/NZS 4130, EN 1555-2 and EN 12201-2, see guideline table on next page.

Pipe Diameter	
Min Pipe Diameter	Max Pipe Diameter
16.0	16.3
20.0	20.3
25.0	25.3
32.0	32.3
40.0	40.4
50.0	50.5
63.0	63.6
75.0	75.7
90.0	90.9
110.0	111.0
125.0	126.2
140.0	141.3
160.0	161.5
180.0	181.7
200.0	201.8
225.0	227.1
250.0	252.3
280.0	282.6
315.0	317.9
355.0	358.2
400.0	403.6
450.0	454.1
500.0	504.5
560.0	565.0
630.0	635.7
710.0	716.4
800.0	807.2

Check the pipe outer diameter at a distance equal to 5% of the pipe outer diameter from the pipe end using a Pi tape. If the outer diameter is smaller than the standard definition (this can occur due to pipe reversion or necking) cut back the measured section of the pipe and re-measure as described above.

# Pipe Preparation

Pipe preparation is the basis of the ElectroFusion process.

Regardless of the fitting manufacturer, fittings will not perform to their full ability if the preparation has not been performed in a proper manner as instructed by the manufacturer.

**The pipe preparation includes few simple yet important steps described below:**

## Cutting of the pipe:

The pipe ends must be cut square and even.

Cutting the pipe square is extremely important.

Failure to cut the pipe square may leave the heating wire uncovered. This can lead to short circuit, overheating, uncontrolled melting and even sudden ignition. Remove any burrs or shavings from the pipe ends.

## Various approved pipe cutting tools

1. Rotational pipe cutter
2. Pipe cutter
3. Rotational pipe cutter (S-type)



1.



2.

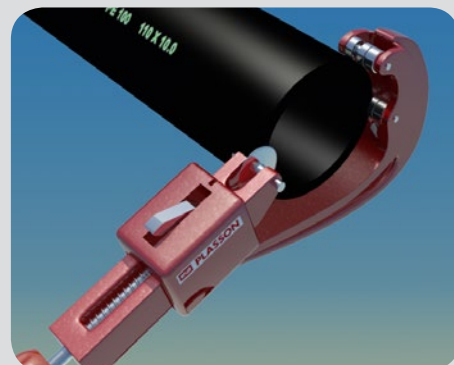

3.

## Marking and scraping:

In order to achieve a good weld the outer oxidized surface of the pipe must first be removed. Mechanical peeling tools are strongly preferred, as they achieve a consistent pipe surface preparation. Hand scraping is less recommended due to inconsistent peel strip removal and is known to be time consuming and onerous to adequately prepare a complete pipe end, particularly for larger diameter pipes.

Clean pipe ends on the outside with Plasson Pipe wipes to remove any rough dirt that might damage the tools used.

### Mark the required scraping length

Before scraping the pipe, measure the insertion depth of the fitting. With the fittings still in the bag, place alongside the pipe end and put a witness mark on the pipe at half the fitting length plus about 2cm to enable visual checking of the scraped area after jointing.

Scrape pipe and spigot ends on fittings up to measurement mark to remove all oxidation and contaminants. Use Plasson rotational scraper.

## Measure the insertion depth

1. Measurement of pipe insertion
2. Mark half the fitting length +2cm

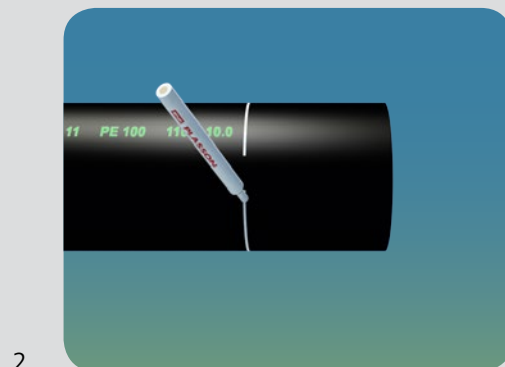
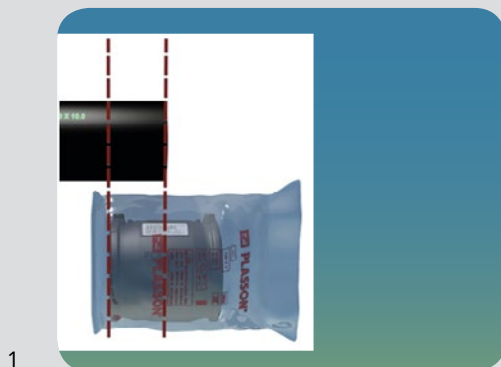

## Surface Preparation - Peeling:

In order to achieve a good weld the oxidised surface of the pipe must first be removed. The removal of this oxidised surface layer is achieved using a mechanical peeling tool. Mechanical peeling tools are strongly preferred, as they achieve a consistent pipe surface preparation. Hand scraping, is not recommended due to inconsistent peel strip removal and is known to be time consuming and onerous to adequately prepare a complete pipe end, particularly for larger diameter pipes.

Peeling of PE Spigot fitting ends is not required, if the fitting is stored in its original packaging and removed immediately prior to use.

The following table regarding peel depths apply generally to socket electrofusion method.

Pipe Peel Depth Requirements	
Pipe DN	Peel Depth (mm) see note
≤ DN25	0.2 Maximum
DN32 - DN63	0.2 - 0.3
DN75 - DN225	0.2 - 0.4
> DN225	0.3 - 0.5

NOTE: If entry of the pipe or fitting spigot into an electrofusion coupling is still restricted after the oxidised layer has been removed, the pipe can be scraped down to the permissible minimum outside pipe diameter as in the above table. In this case, the thickness removed may be greater than the thickness stated above.

<b>Minimum Allowable Pipe Diameter After Peeling</b> (measured at the halfway point along the fusion zone using clean equipment to avoid contamination)	
Pipe DN	Minimum mean outside diameter (OD) of prepared pipe (mm)
16	15.6
20	19.6
25	24.6
32	31.4
40	39.4
50	49.4
63	62.4
75	74.2
90	89.2
110	109.2
125	124.2
140	139.2
160	159.2
180	179.2
200	199.2
225	224.2
250	249.2
280	279.0
315	314.0
355	354.0
400	399.0
450	449.0
500	499.0
560	559.0
630	629.0
710	709.0
800	799.0
900	899.0
1000	999.0
1200	1999.0

## Pipe re-rounding:

ElectroFusion fittings are designed to work on a round pipe.

PE pipes, being manufactured from a flexible material, have the tendency to become out of round due to various reasons.

Such reason may include the following examples:

- **Manufacturer:**  
Process conditions will affect the pipe roundness.  
The pipe manufacturer is obliged to check this parameter, but this should be confirmed by the installer in the field.
- **Pipe coiling:**  
A coiled pipe left in coil shape for a long period of time will become oval due to the bending forces applied onto it.
- **Storage conditions:**  
Pipes are often stacked on top of one other during storage.  
Such stacking will result in the pipes on the lower part of the stack becoming out of round due to the mass applied on them.
- **Time:**  
PE pipes have residual stresses induced into them during the manufacturing process. As function of time, these stresses will “relax” and pipes may loose their initial dimensions.
- **Installed pipe:**  
Pipes that have already spent time under ground might loose roundness due to the ground loads, ground movement and internal pressure

In order for the EF process to work properly, it is essential that the pipe is as round as possible.

The success of the EF process is based among other things on the ability of the fitting to close the gap between the fitting and the pipe and building up an even interfacial pressure for the fusion to take place.



**It is extremely important to re-round the pipe prior to the welding process.**

In order to do so, measure the pipe diameter with a tape measure, find the maximum and minimum diameter points and calculate the difference between these diameters.

Pipe ovality (out of round) =  $d1 - d2$

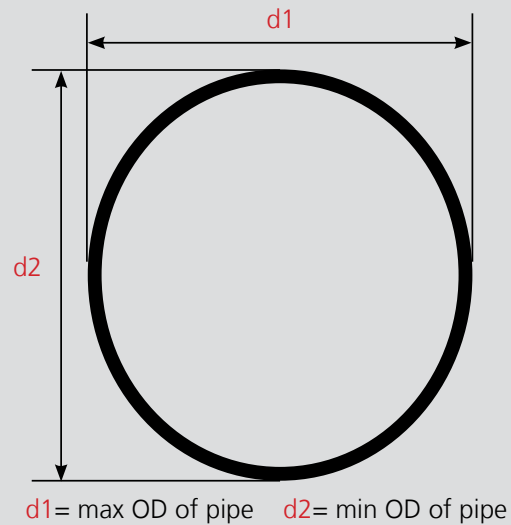

Do not perform an ElectroFusion weld if the pipe does not meet the criteria defined below at the section where the EF fitting is to be welded. Use a pipe re-rounder if necessary to correct pipe ovality.

For pipe DN < 315

$d1 - d2 < 1.5\% \text{ DN}$  or <3 mm (whichever is the smallest value.)

For pipe DN  $\geq 315$

$d1 - d2 < 1\% \text{ DN}$  or < 5 mm (whichever is the smallest value.)

### Clamping and alignment (fitting restraint):

Pipe movement during welding and cooling cycles might occur as well as sources of stress and strain that can be applied on the pipe/fitting assembly. Such phenomena might adversely affect the welding process and must therefore be eliminated.

All ElectroFusion socket fittings (regardless of the manufacturer) must be clamped to the pipes in order to restrain such movement/forces which may affect the welding result.

The use of clamps that will keep the assembly stationary during the weld and cool cycles will help ensure good weld integrity.

Mark the insertion depth on the clean scraped pipe. Ensure that the mark on the pipe reaches the fitting edge when pipe is inserted.

It is very important to make sure that the pipes are in place prior to tightening the clamps.

## Example of clamping and alignment device

1. Misaligned pipes
2. Example of clamping and alignment device

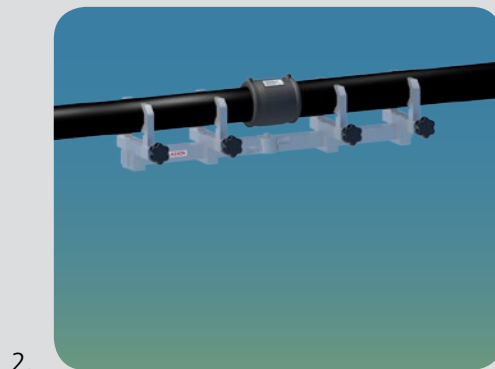
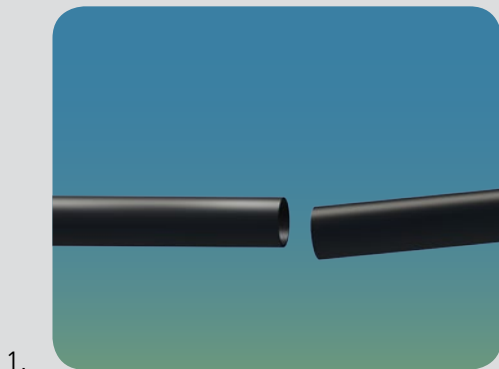

# ElectroFusion Welding

Once all required tooling and parts are ready following the previously described actions we are ready to begin with the welding process.

*Before starting the actual weld, there are a few steps that should be followed:*

- Make sure that the power generator fuel tank is full in order to eliminate the chance of the welding process stopping prematurely (before the required weld time has been completed). **This step is most important with large diameter fittings where the weld times may be much longer than in small fittings.**
- Start up the power generator and wait until the voltage output is stable - we do not want to start work with unstable power input into the controller.
- Once the voltage is stable connect the control box to the power generator.
- Connect the terminals to the fitting.

## Full assembly ready for welding



## Fitting data input

When using Plasson ElectroFusion fittings there are three possible methods for weld data transfer to the control box:

### Plasson Smartfuse<sup>®</sup> system

relevant only to couplers in diameters 16mm up to 355mm.

### What is the Plasson SmartFuse system?

- **Self recognition system**  
Automated recognition system that enables the compatible fusion controller to simply identify the welding time of the fitting. By connecting the red fusion cable from the Plasson control box to the Smart Pin, the identification process starts.

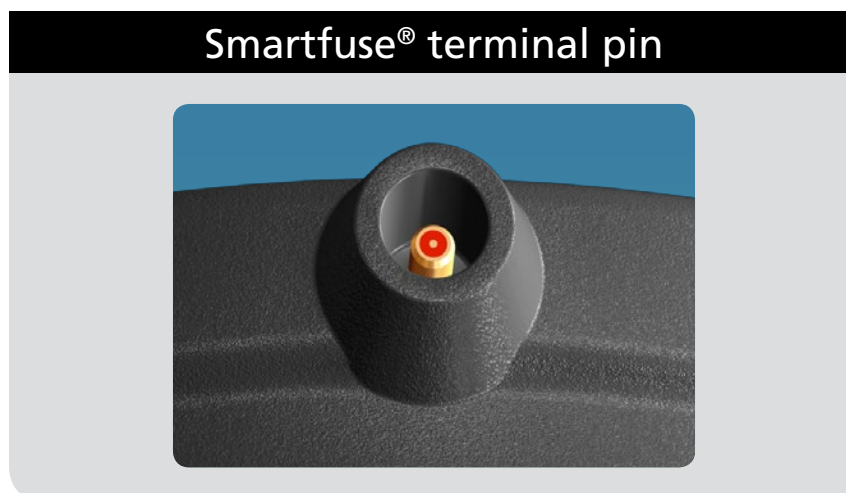

No further inputs or settings are necessary! Confirm that the weld time shown on the controller screen is identical to the weld time printed on the barcode label placed onto the product and just press the START button.

- **Temperature**  
No need for temperature compensation - single welding time regardless of environmental conditions

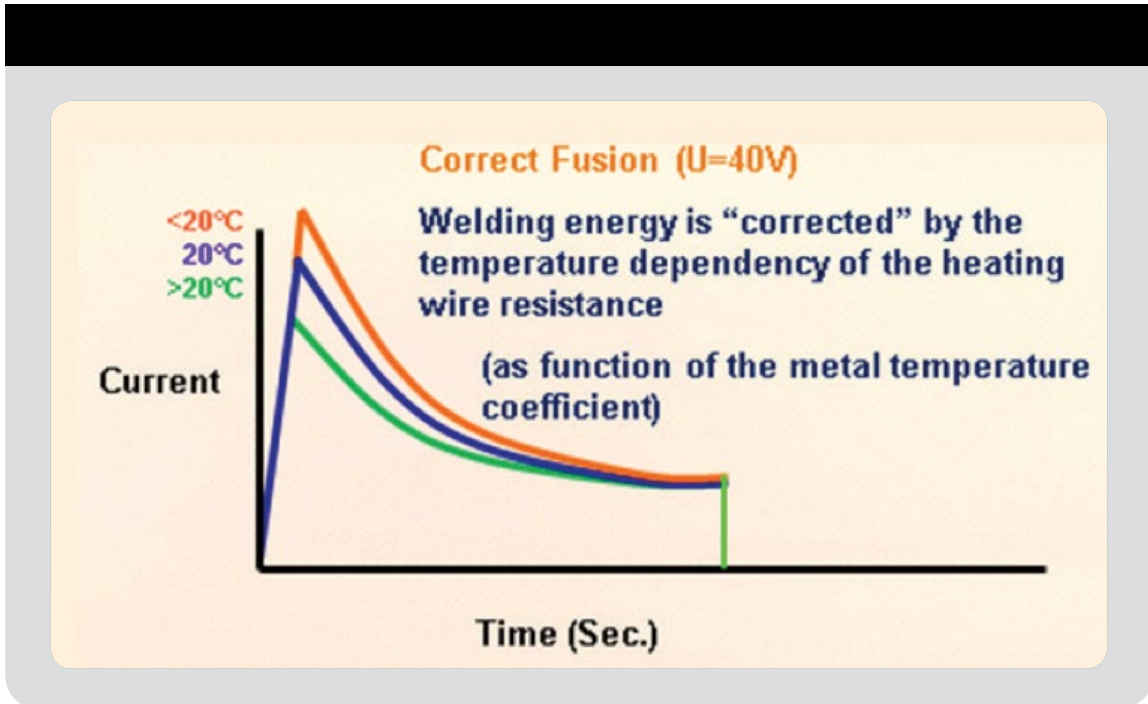

- **Dynamic monitoring**  
Avoid undetected short circuit which may be caused by damage to controller cables or uncontrolled movement of the fitting coils due to melt out.

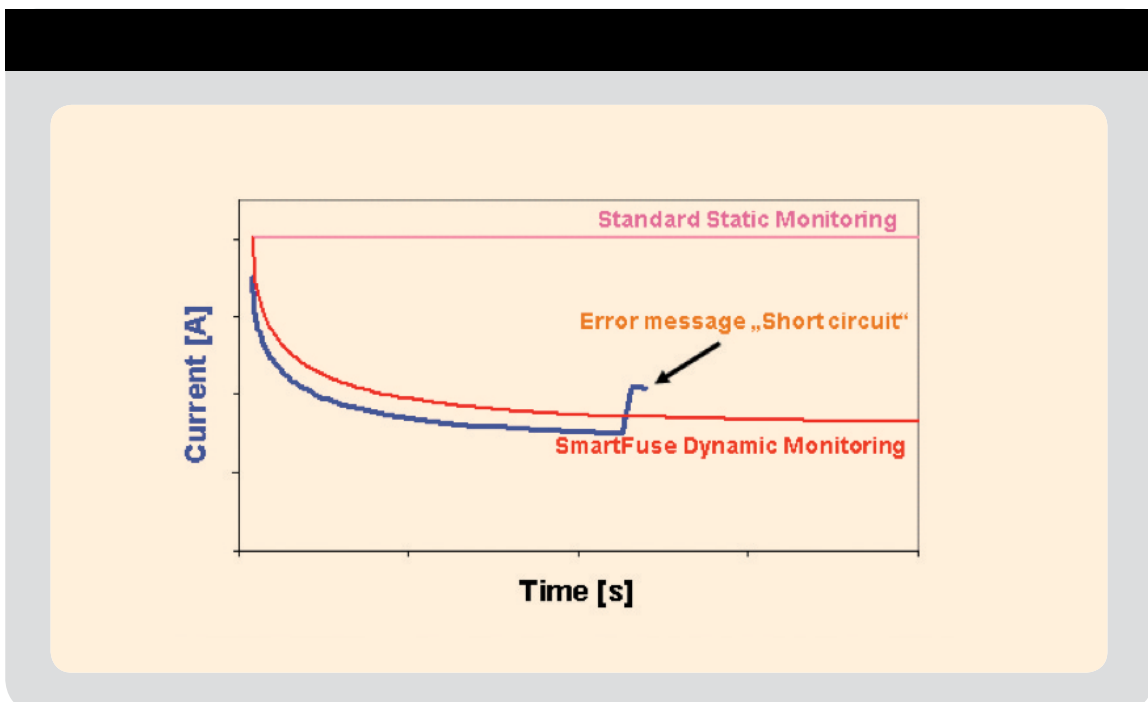

## Product welding barcode

All Plasson ElectroFusion fittings are equipped with a welding barcode label.

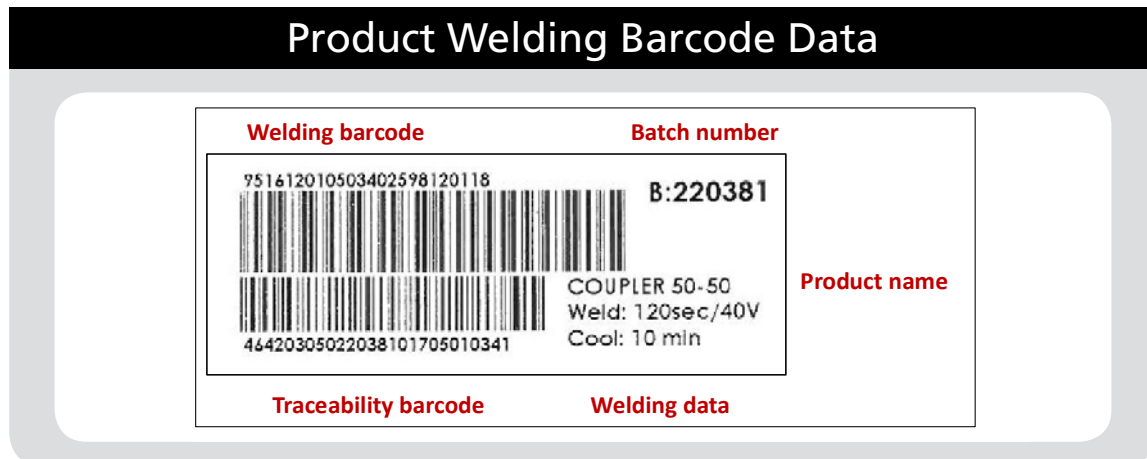

This welding label can be read by the barcode pen or barcode scanner attached to the welding control box.

Scan the label from left edge to right or visa versa without stopping.

Make sure that the weld and cool time appearing on the controller screen are identical to that appearing on the barcode.

If data is identical you are now ready to start the weld process by pressing the START button on the controller.

### If problems are encountered trying to read the barcode check the following:

- Make sure that the controller is ready to accept the welding data.  
If uncertain, press red "stop" button to reset.
- Make sure that the barcode pen is held at an angle to the label and that the reading starts from the white area on one side and ends on the opposite side of the label.
- If a problem still exists check if the light on the tip of the pen is lit - if not, check cable connection to controller is properly connected.
- Check that the pen tip is clean, dry and free of dirt.

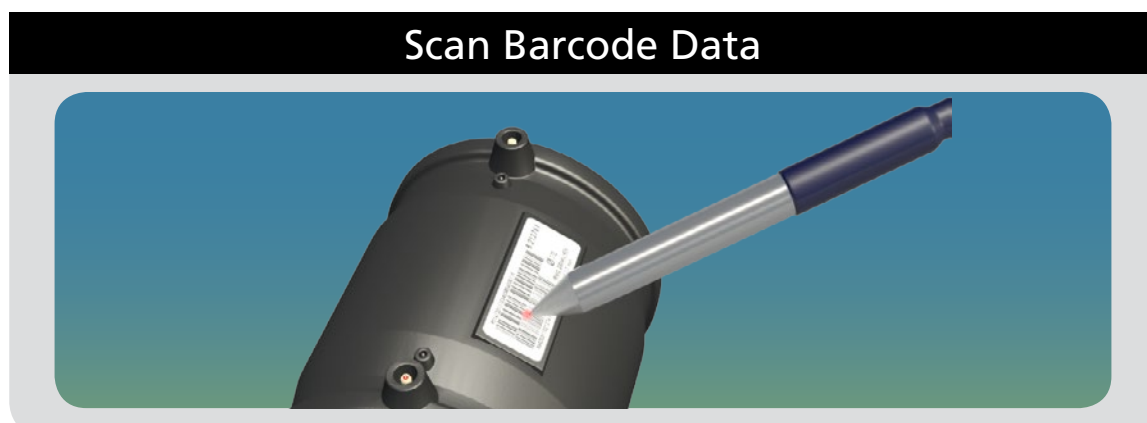

### Manual data input:

Manual input should only be used if the other means described are not available. Manual input is prone to human error and therefore should be done with great care.

Enter into the controller the welding time and weld voltage as written on the barcode label. Recheck the data on the control box screen by comparing to that on the barcode label.

### Post weld inspection

**Once the controller has stopped the weld cycle there are a few things that should be checked by the welder.**

#### Controller:

Check that the actual weld time is the full weld time defined for the product and that no error message is showing on the controller screen.

#### Product:

Check that the rising pin/pins (melt indicator) on the product have risen. The rising of the Melt Indicator pin is dependent on many factors, such as the geometry of the rising pin, the gap between the pipe and the fitting, pipe out-of-roundness, the ambient temperature and others. The Melt Indicator indicates only if a weld has been performed (or not).

The melt indicator does not give any indication of the quality of the weld or if the full weld cycle has been completed. Any rising of the Melt Indicator pin, even a small one, indicates that a weld has been performed.

The indicators are used to highlight if a more detailed inspection of the joint is required.

### Sample of raised melt indicator after welding

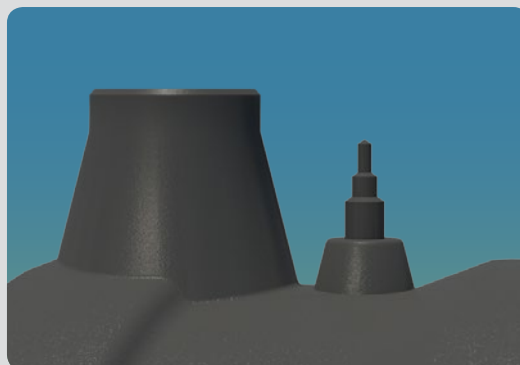

**In the event that the pin does not rise, the supervisor or operator must investigate the following to determine if the joint is satisfactory by confirming all the following features are within specification:**

- Dimensional check and compliance of the pipe or spigot OD and ovality.
- The pipe dimension within the fusion zone should be compliant with the standard definitions.
- That the input power supply to the ElectroFusion control unit is stable without disruption, and no error messages are reported on the display panel.
- That the heat fusion parameters are correct.
- The pipe to fitting alignment is correct with no visible plastic extruded out from the fitting.

It is possible that a good weld has been performed even if the MI did not rise. If the parameters above have been checked and no problem could be detected the weld need not be rejected.

## Cooling time

The defined cooling time mentioned on the product barcode is an integral part of the ElectroFusion process and should be adhered to - it is a critical part of the welding process, and is often overlooked and misunderstood.

**In order to help understand the importance of this stage we shall look at the full fusion cycle and follow its phases:**

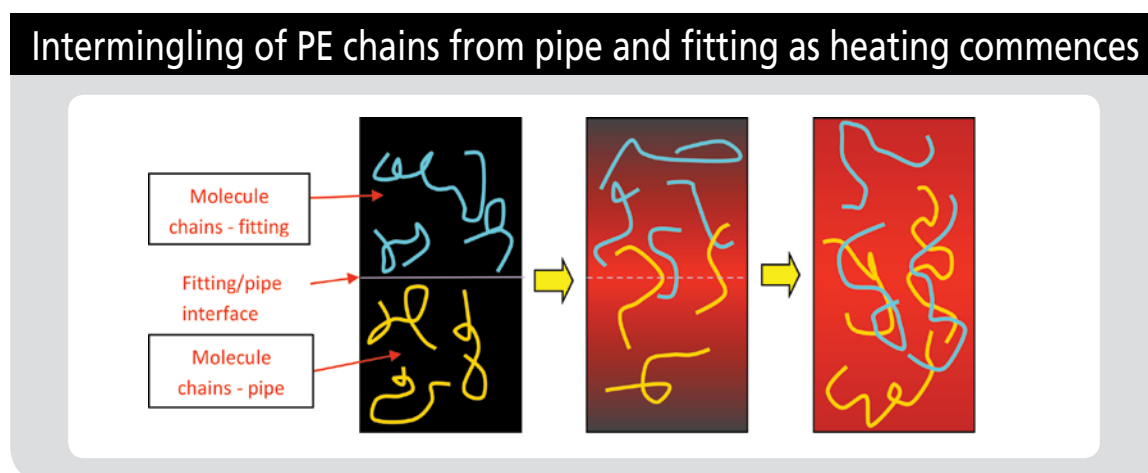

The Polyethylene on the fitting side begins to melt and its volume increases. The melt begins to flow and fill the gap between the fitting and the pipe, and once the pipe surface comes in contact with the hot flowing melt it starts to melt as well and a "melt pool" starts to build up between fitting and pipe as the current continues to be applied.



As the material continues to expand in volume the pressures in the interface zone builds up, and material from the pipe and fitting intermingle. Once the current is stopped, the cooling process begins and the material will start to re-solidify. Given sufficient time, the melt will solidify and the melt pool will cool down in a way that the material will regain its flexibility and strength as they were prior to welding.

Any handling, stresses or movement of the assembled pipe and/or fitting during the welding time or the cooling time may result in a reduced joint performance. Only after completion of the cooling time mentioned on the fitting can the clamping tools and all other surrounding equipment may be dismantled. For pressure testing, we recommend waiting a time equivalent to 4 X cool time mentioned on the barcode label before applying full test pressure.



# EF Installation Instructions

## Socket fittings

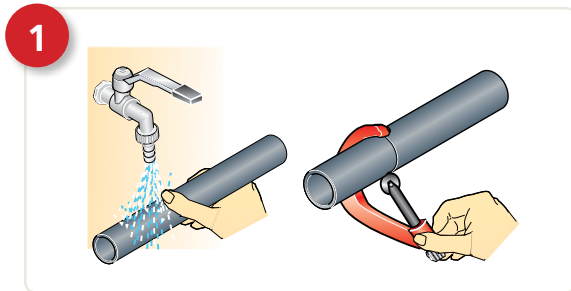

Clean pipe and cut ends squarely

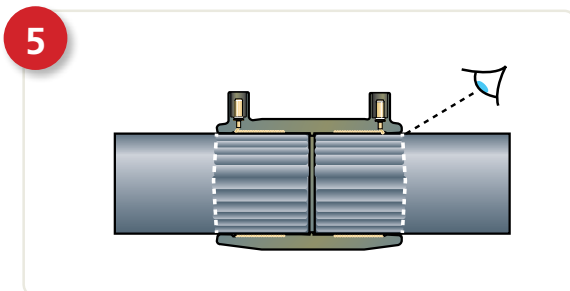

Stab pipe completely into fitting

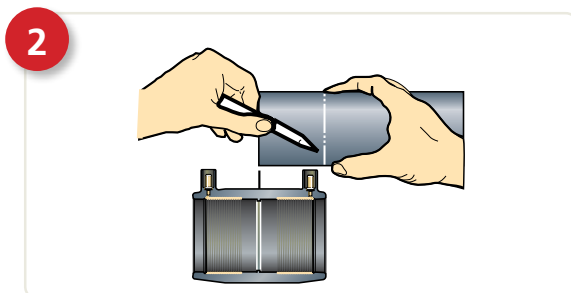

Mark stab depth on pipe

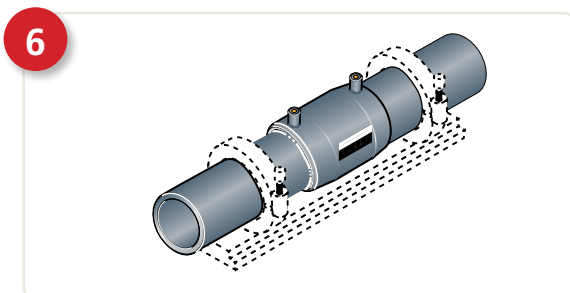

Align and clamp pipe

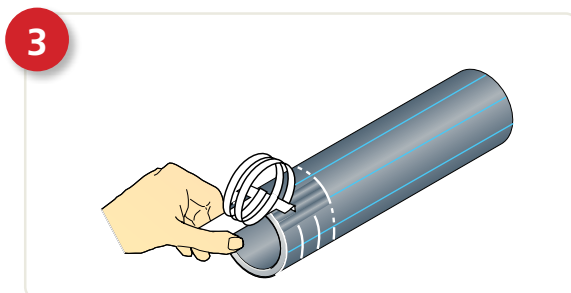

Scrape pipe

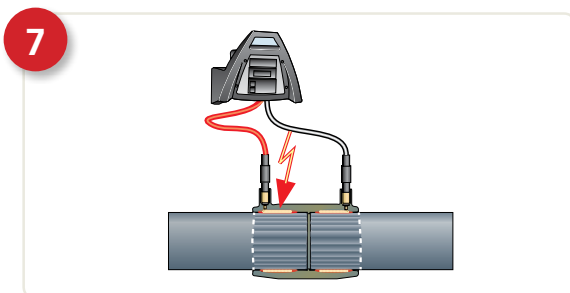

Fuse the joint



Clean with suitable degreasing agent

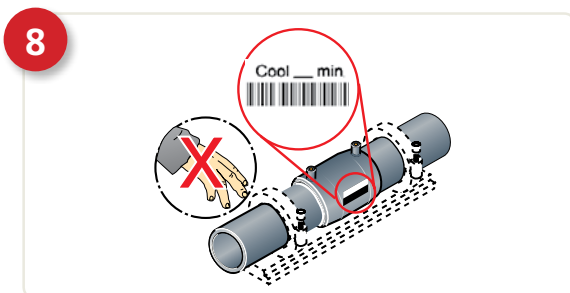

Do not disturb joint during cooling time

## Installation Highlights

### Large diameter couplers ( $\geq 450$ mm)

#### Re-rounding

Even small amounts of ovality in large pipe will result in large gaps between the pipe and the fitting. It is critical that pipe is correctly re-rounded prior to attempting assembly and welding of the fitting.

Plasson has developed a specialised tool to assist this process.

### Re-rounding Tools

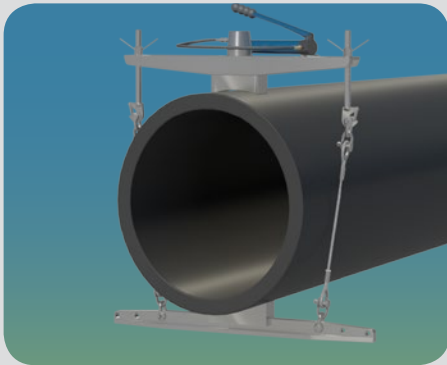

Hydraulic tool

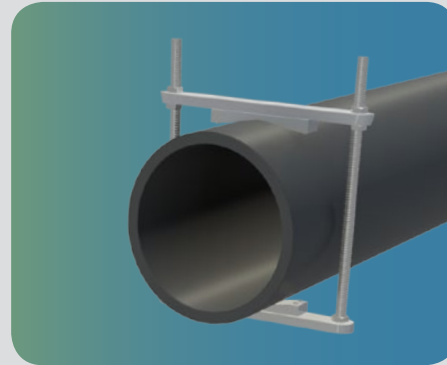

Mechanical tool

#### Scraping

Correct scraping is critical - as with all EF.

Rotational scrapers are available from Plasson for all fitting diameters.

Hand scraping is not recommended on large bore due to the difficulty in ensuring a complete even scrape.

### Plasson scrapers for large diameter pipes



## Suitable control boxes and generators

Large diameter fittings require heavy-duty controllers and generators to supply the necessary power. This heavy load necessitates cooling of the transformer between welding cycles.

In response to this common problem, Plasson has developed a new controller, PolyControl Plus, with integral cooling and novel power transformer technology to reduce cycle time to a minimum.

**The recommended controllers are:**

### Plasson Polymatic or Polymatic Plus

1. Plasson Polymatic
2. Plasson Polycontrol plus



1.



2.

#### Plasson polymatic or polymatic plus

- Allows at least 2 successive welding cycles without pause.
- Efficient in hot and cold weather
- Requires 40 minutes cooling after 3,500 seconds of welding
- Generator: single phase 220V, 5.5 kVa - minimum 16A

#### Plasson Polycontrol Plus

- Allows at least 4 successive welding cycles without pause.
- Efficient in hot and cold weather
- Requires only 10 minutes cooling after 7,000 seconds of welding
- Generator: single phase 220V, 4.5 kVa - minimum 16A

## Clamps

Clamps are required to ensure alignment and to prevent movement during welding and during the period between welding the second side of the coupler

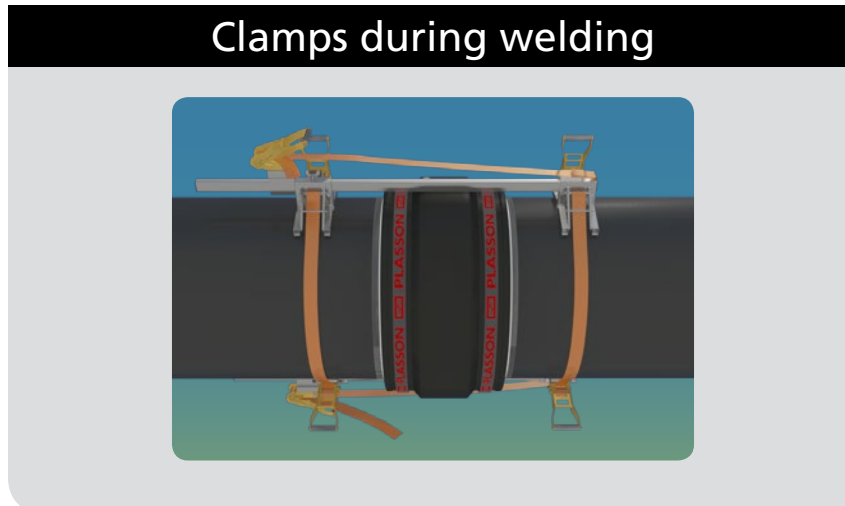

## Important notice

The fabric straps on the large couplers are not designed for use as lifting devices and should not be loosened or removed before, during or after welding. The straps will become loose after the cooling cycle is completed - this is a result of the coupler shrinkage and is no reason for concern.



## Warning

All welding electrical equipment should be checked to ensure it is in good operating condition due to the long weld times in large bore fittings. Damaged leads, loose terminal tips, poor connections could result in over heating or electrical faults/over heating during welding.

# EF Installation Instructions

## ElectroFusion procedure - all saddles

1

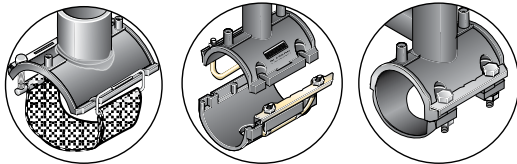

Welding instructions for all Plasson ElectroFusion saddles.

5

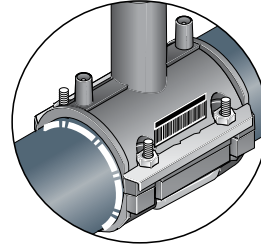

Assemble saddle on scraped pipe and tighten nuts and bolts crosswise.

2

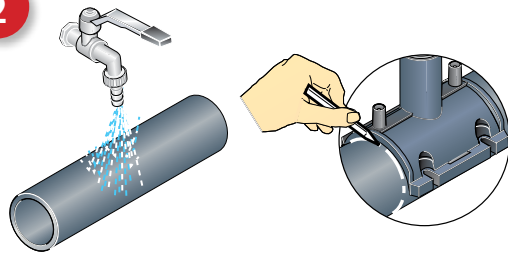

Clean pipe then draw saddle boundaries on pipe.

6

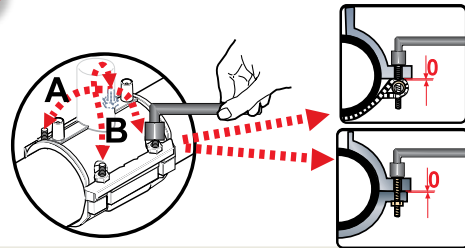

Tighten until upper and lower saddle parts are mated (zero gap).

3

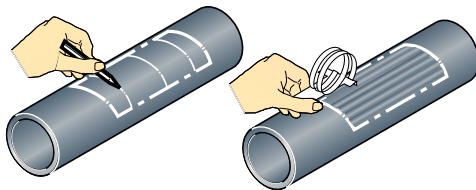

Add marks on pipe inside boundaries and scrape pipe fully inside perimeter.

7

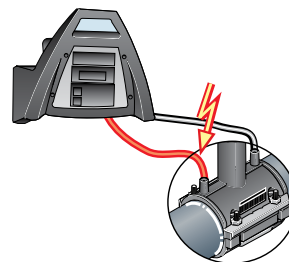

Fuse fitting.

4

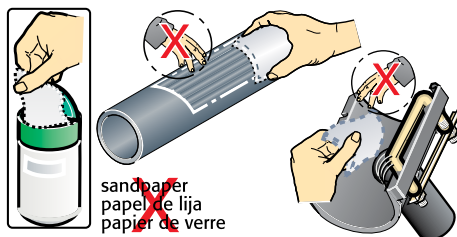

Degrease saddle surface and scraped pipe with appropriate cleaning agent.

8

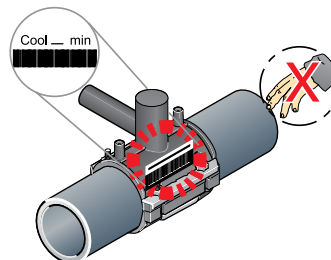

Allow to cool. Cool additional 30 minutes prior to tapping and pressure testing.

# EF Installation Instructions

## Tapping instructions for Tapping Saddle

1. Push down on sleeve to ensure correct starting position.
2. Tap pipe by turning wrench clockwise to lowermost position of the sleeve.

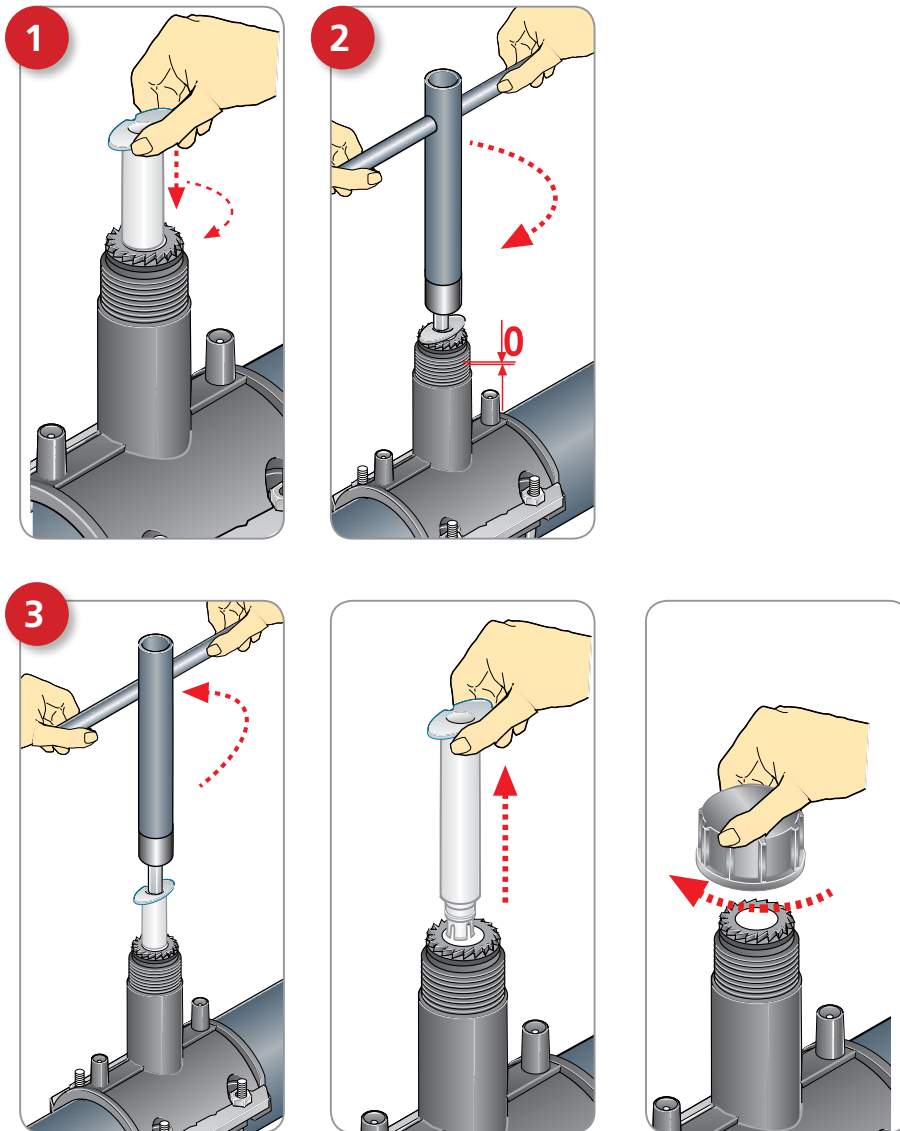

3. Unscrew to uppermost position (resistance increases significantly). Then add ½ turn, not more, to tighten firmly for good seal. Remove sleeve, then screw on cap and tighten firmly.

# EF Installation Instructions

## Flex Restraint



1 Clean the Pipe. Mark product boundaries on the pipe, draw lines within marked area.



2 Scrape marked area, ensure all lines are fully removed.



3 Clean restraint & scraped pipe surface with appropriate cleaning agent.



4 Clamp the Flex Restraint by using a 1¼" (or larger) ratchet tie down strap. Multiple restraints may be clamped together.



5 Make sure flex restraints are in full contact with the pipe surface. Air gap is not allowed.

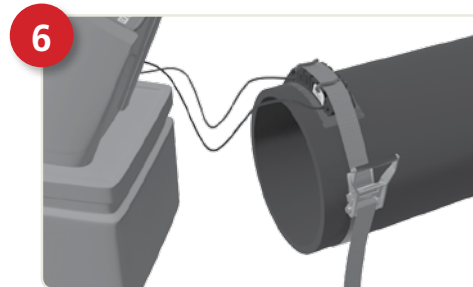

6 Connect to controller and weld flex restraint.

7

Welding Parameters			
Ambient temp		Manual input	
F°	C°	Time (sec)	Voltage (v)
14 to 20	(-)10 to (-)6	330	40
21 to 30	(-)5 to (-)1	315	40
31 to 50	0 to 9	300	40
51 to 80	10 to 26	270	40
81 to 113	27 to 45	250	40

Scan barcode for automatic input.  
If manual input is required, use data table above.

8

Allow to cool for the indicated cool time before removing clamping strap. Wait additional 4xcool time before applying full load.



# EF Installation Instructions

## Large Diameter Saddles

\* Install only with Plasson dedicated clamping tool for large saddles.



1  
Scrape and clean the pipe. Scrape twice if manual scraper is used. then locate the saddle on the pipe



2  
Place the appropriate tightening plate according to saddle type and size over saddle outlet.



3  
Fit the jig ring on the spigot; place in the appropriate direction pending on the spigot diameter used (90mm, 110mm, 125mm or 160mm)



4  
Shift the ratchet to its "loose" position, and attach to the hooks. both pulling devices should be placed in the same direction.

### **IMPORTANT NOTICE:**

The enclosed instructions should be regarded only as a reminder for qualified welders.



Weld the fitting. Remove the straps only after cooling time has elapsed.



Wait 4 x cooling time, then test weld integrity at 1.25x working pressure.



Tighten the strap first by hand and then using the ratchets until the gap in the Tension Force Indicator (TFI) is closed.



Drill the pipe.

**SAFETY:**

Follow all the safety and operating instructions provided by the tool, drill and the cup saw manufacturers.

# Pressure Test Device

## For Plasson Large Bore Saddles

The large bore saddles are equipped with a special port to enable testing the integrity of the welding by applying water pressure prior to the cutting of the coupon.

The water pressure is applied between the pipe surface and a temporary integral blanking plug at the saddle, through a PE tube welded to the saddle.

The pressure line is connected to the tube by compression fitting for plastic pipe.

We recommend the use of a push-fit, quick release fitting - usually in use for pneumatic systems.

For pressure source - we recommend the use of a standard pump for pressure testing of plumbing systems. The max test pressure is 1.25 x working pressure.

### Pressure Test

1. Test port located within outlet
2. Pump connected to pressure port
3. Test pressure applied



1.



2.



3.

## Incorrect EF Jointing

The ElectroFusion system has over the years proved to be an extremely reliable jointing system, however, failures do emerge from time to time.

In the vast majority of failures the root cause is due to problems resulting from incorrect installation.

The most common failures are associated with poor surface preparation -“contamination failures”.

### Make up of typical ElectroFusion failures

- Contamination - poor preparation: 80%
- Geometry - pipe not cut square etc. 10%
- Movement - pipe not clamped: 10%

### Contamination failures

Contamination failures result in incomplete jointing due to an oxidized or dirty layer acting as barrier and preventing the plastic of the fitting fusing with the plastic of the pipe.

### Common causes of contamination:

- Poor scraping due to uncompleted hand scraping or blunt mechanical scraper
- Dirt
- Mud
- Dust
- Grease
- Oils (two stroke oil etc)
- Moisture
- Hands (body grease, sunscreen,...)
- Solvents
- Unsuitable Wiping Fluids
- Unclean or unsuitable Rags

## Alignment errors

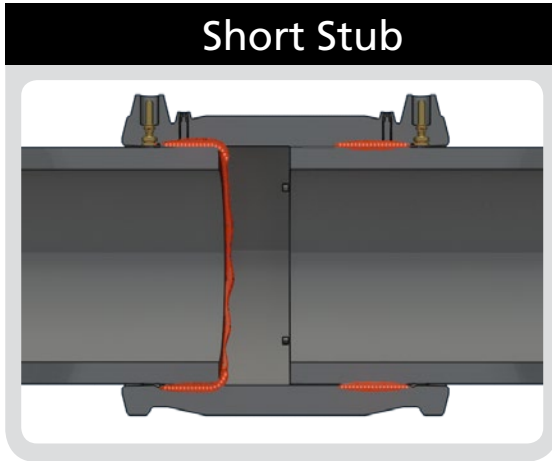

**Short stub:** can result from Improper insertion of the pipe or movement during weld due to incorrect clamping.

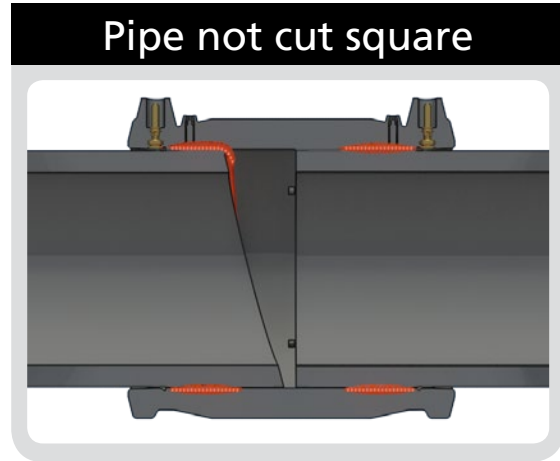

**Pipe not cut square.**

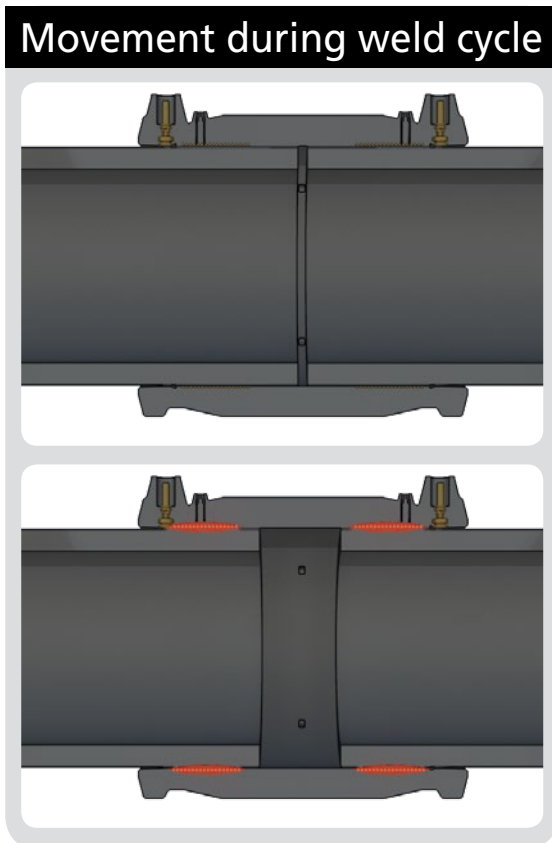

**Pipe movement during weld cycle:** due to external forces or forces induced by the welding process, when the pipes are not clamped properly.

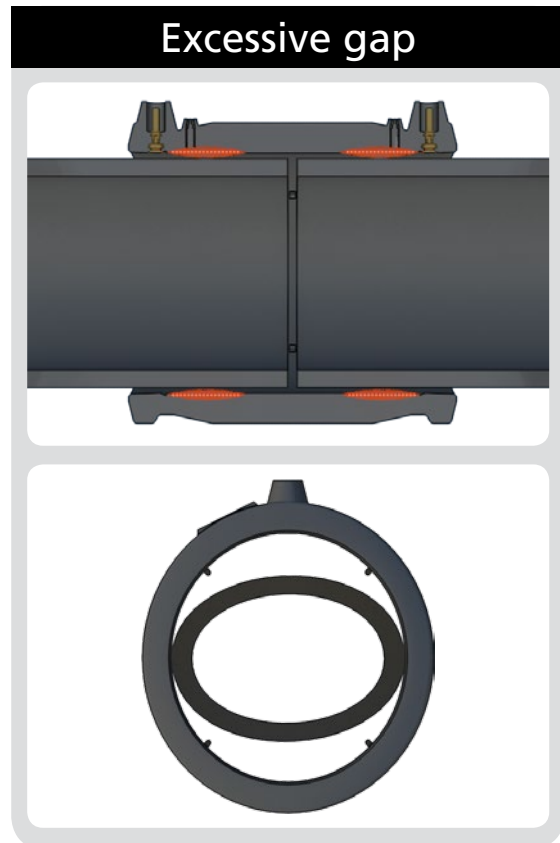

**Excessive gap:** excessive gap between pipe and fitting due to pipe out of roundness, undersized pipe or over scraping of pipe surface.

# Product BRT

## (Batch release test) - sample of report

The following report is a typical BRT report available online for each and every production batch produced in Plasson and includes the results of all tests performed to ensure batch to batch quality is maintained.

BRT is not an ASTM demand but is required by other international standard to which Plasson products are tested and approved.

ELECTROFUSION PRODUCTS PROCEDURES. UPDATED ON 01/05/2009. APPROVED BY ANDREY REZNIK				English
PROCEDURE EFF 158 EDITION NUMBER 8 - PAGE 1 OF 1				
				
<b>Inspection Certificate</b> <b>According to EN 10204 - 3.1</b>				
<b>Product + Dimensions</b> <b>COUPLER 180 -180</b>				
<b>Catalog No.</b>	490104180N	<b>Batch No.</b>	215695	
<b>Assembly Date (ww-yy)</b>	52-10	<b>Production Period</b>	1-52-10	
<b>Raw Material</b>	XS10B BLACK FINATHENE PE-100	<b>Raw Material Batch No.</b>	S004119102	
<b>Test name</b>	<b>Standard</b>	<b>Conditions</b>	<b>Requirement</b>	<b>Results</b>
<b>A RAW MATERIAL</b>				
<b>1. Melt Flow Rate</b>	EN ISO 1133	MFR 190°C/5kg	0.224-0.336 g/10min	0.274 g/10min
<b>2. Density</b>	EN ISO 1183	23°C	0.949-0.968 g/cm <sup>3</sup>	0.955 g/cm <sup>3</sup>
<b>3. Oxidation Induction Time</b>	ISO 11357-6	200°C	> 20 min	pass > 20 min
<b>B FITTING</b>				
<b>1. 80°C Stress Crack Resistance</b>	ISO 1167	80°C, 11bar	165 h	170 h
<b>2. Dimensional Check</b>	EN ISO 3126	23°C		(available in approval records)
<b>3. Surface Condition</b>	EN 1555-3			pass
<b>4. Visual Check</b>			Internal procedure	pass
<b>5. Fitting I.D. Resistance</b>	EN 1555-3	23°C	0.528 - 0.595 ohm	0.561 ohm
The pass/fail criteria are based on the requirements of the following standards or drafts:				
ISO 8085-3	EN 12201-3 water systems	AS / NZS 4129-2008	DVGW GW 335 B2	
AFNOR NF 136	EN 1555-3 gaseous fuel systems	DVGW 305-2		
Pressure tests and fusing tests to welded pipes are carried out in order to test the fittings.				
The test results appearing in this certificate have been taken from records of internal testing of fittings produced from the same batch of raw material and from the same production period as those fittings included in this delivery.				
We hereby certify that to the best of our knowledge and understanding, the above tests have been carried out in conformance with the requirements of the standards mentioned above.				
Date: 23/06/2013 This certificate has been printed using a data processing unit, and therefore is not signed.				
Andrey Reznik - Quality Manager				

# Technical Specifications for Plasson ElectroFusion Fittings

## Fittings material

All Plasson ElectroFusion fittings are produced from material class PE100 which conform to international standards for potable water and natural or suitable manufactured gas systems.

Production from PE80, available upon request.

## Pressure rating

All Plasson ElectroFusion Fittings are rated:

- PN 16 (Water)
- GAS PE100 SDR11

Lightfit are rated:

- PN10 (Water)

**Note:** for further details, see the notations on each fitting or consult your Plasson representative

## Fusion parameters

Fusion time and cooling time are clearly marked on the barcode label of each and every fitting. In addition, they may be obtained using a barcode reader. Couplings of diameter  $\leq 355$ mm and wastewater saddles have a red colored self-recognition terminal pin that communicates fusion time automatically to Plasson Controllers (the Smart-System solution) when the terminals are connected according to instructions.

All Plasson's fittings may be welded successfully at ambient temperatures from -10 to 45°C. For more details please contact your Plasson representative.

## Standards

Plasson ElectroFusion fittings are designed, tested and quality controlled according to Plasson's internal standards.

These standards are based on the following international standards:

ISO 8085

EN 1555

EN 12201

NF 136

AS/NZS 4129

WIS 4-32-14

WIS 4-32-15

## Quality

Plasson has incorporated a quality assurance system in accordance with ISO 9001. Operating approval according to ISO 9001 was granted to Plasson by the Israel Standards Institute. The ISO 9001 quality assurance system imposes stringent standards of control throughout the manufacturing processes.

## Marking

Plasson's EF fittings are marked with the following information:

Aspect	Marking
Manufacturer's Name	Plasson
Pipe's nominal diameter	e.g. d90
Design application for gas	e.g. Gas PE100 SDR11
Design application for water	e.g. Water PN16
Suitable pipes	e.g. SDR7.4-11
Production date*	e.g. 1 03 13

\*Production date digits description:

Number of batch produced in week	Week no.	Year
1	03	13



Traceability barcode is marked on the barcode label according to ISO 12176-4:

Digit	Description
1	Quantity on dimension in fitting (1 or 2)
2	
3	Code for Plasson
4	
5	Fitting type (coded)
6	
7	Dimension – in mm or coded for two dimensions
8	
9	
10	Batch number
11	
12	
13	
14	
15	
16	Production site / department
17	
18	SDR of the fitting
19	Raw material type
20	
21	
22	
23	virgin raw material
24	PE type
25	MFR of the raw material
26	Control digit (check sum)

# Notes

---

---

---

---

---

---

---

---

---

---

---

---

---

---

---

---

---

---

---

---

---

---

---

---

# Notes

---

---

---

---

---

---

---

---

---

---

---

---

---

---

---

---

---

---

---

---

---

---

---

---

# Electrofusion Installation Manual



**APS** **ASMUSS  
PLASTIC  
SYSTEMS**  
LEADERS IN PIPELINE TECHNOLOGY

Albany Branch  
34 Arrenway Drive,  
North Shore City 0632  
P.O. Box 100244,  
North Shore City 0745  
Auckland, New Zealand  
Freephone: 0800 000 546  
Fax: (64) (9) 477 2328

Mt Wellington Branch  
6 Gabador Place  
Mt Wellington 1060,  
Auckland, New Zealand  
Ph: (64) (9) 573 0030  
Fax: (64) (9) 573 0040

Sockburn Branch  
5 Paradyne Place,  
Sockburn 8042, New Zealand  
Ph: (64) (3) 348 4087  
Fax: (64) (3) 343 0953

**Pipe • Fittings • Valving  
Measurement & Control**

**[sales@plasticsystems.co.nz](mailto:sales@plasticsystems.co.nz)  
[www.asmussplasticsystems.co.nz](http://www.asmussplasticsystems.co.nz)**