



 PLASSON

## ELECTROFUSION TOOLING



 PLASSON 225mm/SDR17

## Content

### ELECTROFUSION TOOLING

Control Box Comparison Table	17
Electrofusion Control Boxes	18
Welding Cables & Accessories	18
Welding Terminal Pin Adaptors	18
Bar Code Readers And Accessories	19
Pipe Cutting	19
Pipe Peeling	20-21
Rerounding Tools	22-23
Squeeze Off Tools	23
Pipe Cleaning	24
Pipe Clamping	24
Specialized Installation Tooling For PLASSON Products	25
Large Bore Saddles Installation Tools	26-27
Tools for Drilling	28
Hot Tapping Tools	28

## Control Box Comparison Table

Page 18	SmartFuse 180	
Page 18	Polymatic Plus USB	
Page 18	Polycontrol Plus V2	

## Welding Cables & Accessories



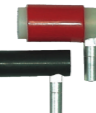

Page 18	Welding Cables For Monomatic Or Digimatic Universal (4.0/4.7Mm)	
---------	---	---

## Welding Terminal Pin Adaptors





Page 18	Adaptors	
Page 18	Smartfuse Adaptors	

## Bar Code Readers and Accessories







Page 19	Reading Pen 2DL	
---------	-----------------	---

Page 19	Barcode Scanner	
Page 19	Orange Transport Case (Monomatic/Digimatic/Polymatic Plus)	
Page 19	Magnetic Circular Pipe Ruler	
Page 19	Pi-Meter 20-700mm with Vernier 0.1mm	
Page 19	Marking pens broad white (12pens/1box)	

## Pipe Cutting







Page 19	Pipe Shears	
Page 19	Rotational Pipe Cutter (S-Type)	
Page 19	Rotational Pipe Cutter	
Page 19	Rotary Circular Saw Kit	

## Pipe Peeling

Page 20	Hand Scraper	
Page 20	Rotational Peeling Tools	
Page 20	Pipe End Peeler	
Page 21	Chain Peelers	
Page 21	Electrical Chain Peeler	
Page 21	RI Pipe Beveler	
Page 21	Electrical Saddle Scraper	

## Rerounding Tools

Page 22	(Re-) Rounding Shells	
Page 22	Rounding Pliers	

Page 22	Rerounding Clamp 63-400mm	
Page 22	Rerounding Ring 63-250mm	
Page 22	Hydraulic Rounding Shells	
Page 22	Hydraulic Strap Rounders	
Page 22	Mechanical Rounding Tools	
Page 23	Rerounding Shell	

## Squeeze Off Tools

Page 23	Manual Squeeze Off Tool For Gas Pipes	
---------	---------------------------------------	---

Page 23 | Manual Squeeze Tools



Page 23 | Hydraulic Squeeze Tools



## Pipe Cleaning

Page 24 | Detergents



## Pipe Clamping

Page 24 | Pipe Clamps



Page 24 | Ball Joints for Pipe Clamps



Page 24 | Strap Clamps



Page 24 | Pulling Clamp



Page 24 | Pipe Support



## Specialized Installation Tooling For PLASSON Products

Page 25 | Waste Water Saddle Installation Tools



Page 25 | Tool for Waste Water Saddle 160



Page 25 | Tension belt for Flex Restraint



Page 25 | Tensioning Tool for Sensor Adapter



## Large Bore Saddles Installation Tools

Page 26 | Clamp Kits - Pipes DN250-DN900



Page 26 | Tensioning Tools for Saddle Clamps



Page 26 | Support Bar



Page 27 | Core Cutters



Page 27 | Pressure Test Pump



## Tools for Drilling

Page 28 | Manual Drills (For outlets up to 250 mm)



Page 28 | Saddle Drilling Equipment (For outlets 250 mm and above)

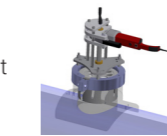

## Hot Tapping Tool

Page 28 | Hot Tapping Tool



### PF-Schweißtechnologie GmbH (PFS)

PLASSON'S range of electrofusion tooling is designed and manufactured by our joint venture partner, PFS. Founded in 1997 in Germany, PFS quickly developed into one of the world's leading manufacturers of plastic welding technologies for pipeline construction. The product range includes a wide variety of electrofusion control units, butt fusion machines, extensive accessories and a complete portfolio of tools for the preparation of plastic pipes for welding.

### High Quality Products

Thousands of customers around the globe rely on the high quality of PFS products.

Product development is conducted by employees with many years of experience, know-how, dedication and with a high capacity to innovate.

Close cooperation with end users of PFS products and systems provides real field feedback to allow refinement of products, even at component level, resulting in products robust enough to handle even the most difficult site conditions.



Turn your PLASSON Control Box into the ultimate welding machine with our **new Smartphone App**.

## Available now



- Features of the Free Upgrade
- ✓ **Smartphone control** of your box, with no mobile network coverage needed
  - ✓ **Improved quality control** with guided welding process and photo capture of crucial steps (kept with the weld record)
  - ✓ **Data recording** including physical location of each weld
  - ✓ Ability to **identify installer** of each weld
  - ✓ Ability to **weld all fittings\***



Smarter plumbing with PLASSON.

\*Monomatic Control Boxes will be limited to emergency welds of other fittings



## Pipe Preparation

Pipe preparation is the basis of the ElectroFusion process.

The pipe preparation includes few simple yet important steps described below:

### Cutting of the pipe:

The pipe ends must be cut square and even.

#### Various approved pipe cutting tools



1. Rotational pipe cutter



2. Pipe cutter

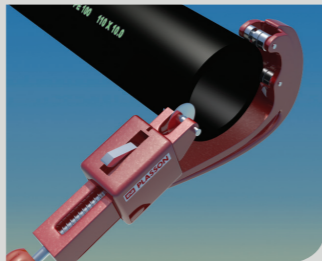

3. Rotational pipe cutter (S-type)

### Marking and scraping:

In order to achieve a good weld the oxide layer of the pipe must first be removed.

Mechanical peeling tools are strongly preferred, as they achieve a consistent pipe surface preparation

#### Hand scraper

When using hand scrapers - perform long even scrapes starting from outside the marked areas to avoid "cratering" in the fusion zone of the fitting until all marks are removed.

#### Rotational scraper

One scraping pass is to be carried out in order to remove approx. 0.2 to 0.3 mm of the outer pipe surface. If the pipe diameter is still too large, additional scraping may be performed in order to facilitate insertion, as long as the average pipe diameter is kept above minimum.

This is the preferred peeling method as it will remove the pipe surface evenly.

#### Rotational Scraper / Hand scraper

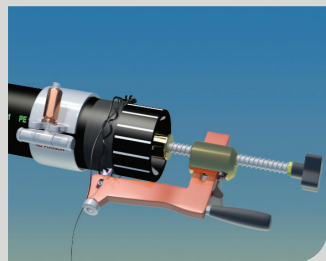

1. Rotational scraper

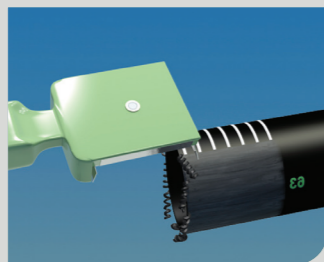

2. Hand scraper

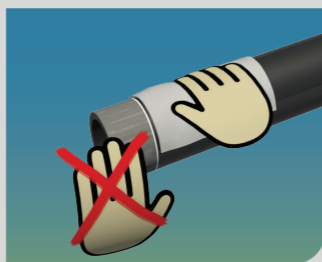

3. Do not touch the scraped area with bare hands after scraping and cleaning

### Pipe rounding:

ElectroFusion fittings are designed to work on a round pipe.

Do not perform an ElectroFusion weld if the pipe does not meet the criteria defined below at the section where the EF fitting is to be welded.

Use a pipe re-rounder if necessary to correct pipe ovality.

#### For pipe DN < 315

$d1 - d2 < 1.5\% \text{ DN}$  or  $< 3\text{mm}$  (whichever is the smallest value.)

#### For pipe DN ≥ 315

$d1 - d2 < 1\% \text{ DN}$  or  $< 5\text{mm}$  (whichever is the smallest value.)

It is extremely important to re-round the pipe prior to the welding process.

In order to do so, measure the pipe diameter with a suitable measuring tool to find the maximum and minimum diameter points and calculate the difference between these diameters.  
Pipe ovality (out of roundness) =  $d1 - d2$

$d1 = \text{max OD of pipe}$     $d2 = \text{min OD of pipe}$

### Clamping and alignment (fitting restraint):

Pipe movement during welding and cooling cycles might occur as well as sources of stress and strain that can be applied on the pipe/fitting assembly.

All ElectroFusion socket fittings (regardless of the manufacturer) must be clamped to the pipes in order to eliminate all mechanical stress in the welding zone.

#### Example of clamping and alignment device

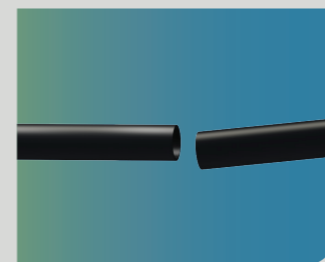

1. Misaligned pipes

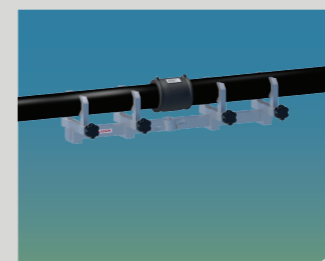

2. Example of clamping and alignment device

## Introduction

The tools in this catalogue are designed for use with Polyethylene electrofusion fittings.

## Plasson SmartFuse (Automatic) Electrofusion Fittings

### PLASSON SmartFuse electrofusion fittings have the following features:

- Automatic Weld Time Recognition System - avoids operator input errors
- Single Weld Time -  $-10^{\circ}\text{C}$  to  $+45^{\circ}\text{C}$  means temperature compensation is not required, no need for operator judgment and possible errors
- PN 16 water/1000 kPa Gas systems - meets the most demanding technical requirements
- PN 10 water/630 kPa Gas systems - for PE pipes down to SDR 33
- Approvalmark International (API) licensed system for EF fittings - No. 2018, AS/NZS 4129

### A Smoother Process

By using PLASSON SmartFuse fittings and PF ElectroFusion Control Unit there is no need for special bar-code reading EF control boxes, or reference to temperature compensation tables, virtually eliminating the margin for error in this area, (provided the process is being carried out within a temperature range of  $-10^{\circ}$  and  $+45^{\circ}\text{C}$ .) however, if users wish to have a control box capable of welding PLASSON SmartFuse Fitting as well as manual or barcode fitting, PLASSON has a control box that can operate both – The Polymatic Plus.

### A Single Weld Time

According to the latest Standards, all electrofusion fittings must be able to produce welds at a temperature range of between  $-10^{\circ}$  and  $+45^{\circ}\text{C}$ , resulting in a variety of designs available to the market.

The PLASSON SmartFuse Electrofusion system ensures that the energy supplied will weld fittings from a minimum  $-10^{\circ}$  to  $+45^{\circ}\text{C}$  at one standard single weld time.

Fittings are tested within this range and are supplied with Approvalmark International (API) Licence.

### No Temperature Compensation

Other fittings being supplied to the Australasian market may meet ISO/EN standards but may require temperature compensation creating a more complex lengthier process that is more susceptible to human error. Where welding time is dependent on the ambient temperature, this requires a special bar-code reading EF control box to sense the temperature, read the fittings bar-code and adjust the weld time accordingly. Any additional work required relies on the legibility of the bar-code and as assumption that the point at which the temperature is read does not widely from the temperature at the pipe/ fitting assembly.

Without a special bar-code reading EF control box, the weld operator will need to estimate the temperature at the joint site, read the temperature compensation tables correctly (if supplied and legible) and enter the new weld time into the box before the weld can proceed. This process relies on operator skill/judgment, is open to mistakes and may need a complex QC form to record the weld conditions used.

## ElectroFusion Control Unit

PF control boxes dynamically monitor the weld process when used with PLASSON ElectroFusion fittings.

- Dynamic monitoring - By continually monitoring the weld current, an ElectroFusion Control Unit will shut down if the current increases above the dynamic tolerance range, thereby avoiding the overheating and anti-oxidant depletion of PE materials which can adversely affect long-term weld integrity.
- Generator variability tolerance - PF control boxes are tolerant to generator variability as they accept a large voltage range and frequency variation.
- Numerous servicing centres for PF welding equipment are available.

### What can go wrong?

Without dynamic monitoring of a PLASSON Automatic Welding ElectroFusion Control Unit, faults may occur unnoticed during the weld process causing the fitting to fail once in general use. Common causes of this can be seen in the diagram below.

## Typical Electrofusion Welding Faults

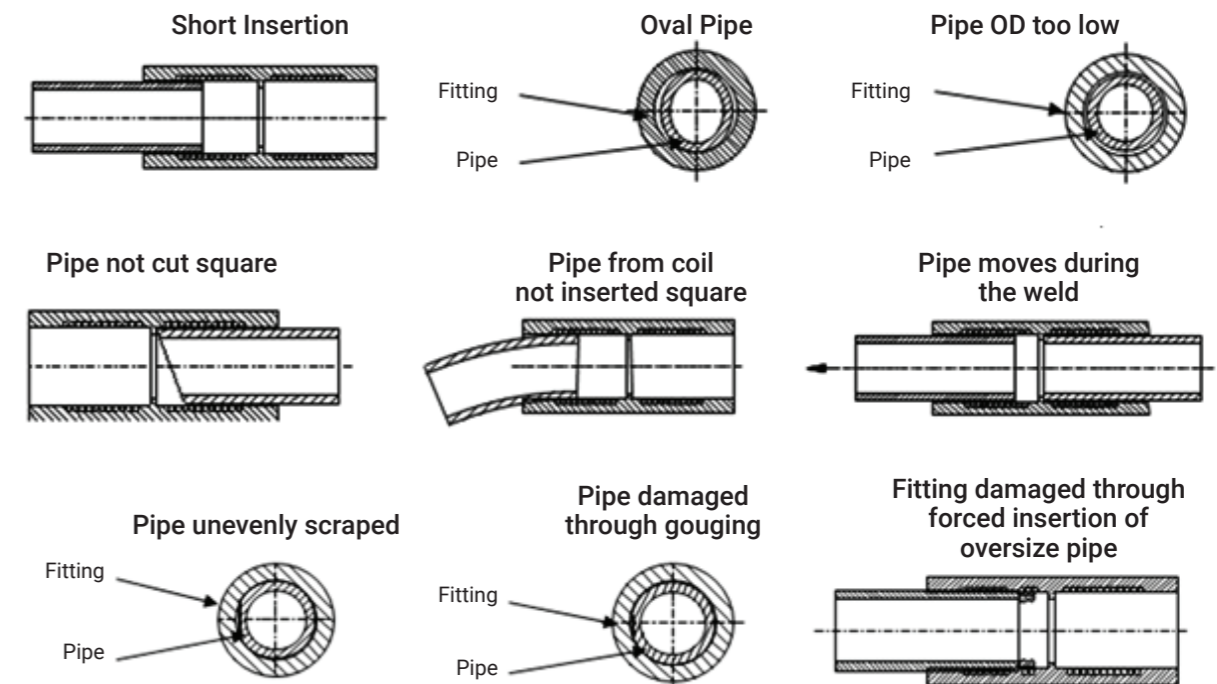

### Please note:

PLASSON Automatic ElectroFusion Control Unit will not carry out this dynamic monitoring process on other manufacturers' fittings.



# POLYCODE

## New **lighter** and **smaller** SmartFuse control box

- ✓ Welds PLASSON fittings
- ✓ Light < 14kg
- ✓ Compact (470 x 370 x 180mm)
- ✓ Bluetooth enabled for smartphones using PLASSON SmartFuse App
- ✓ Use App to automatically determine and record welding parameters
- ✓ 10 amp plug
- ✓ Tough weather-proof carry case



## Control Boxes

Control Box Comparison Table

Features	POLYCODE	PF Monomatic	PF Polymatic Plus USB	PF PolyControl Plus V2
3M Lead	29143.0308S324			
5M Lead		29143.0307.000	29143.0307.303	29143.F0318V112
Fitting size	up to 160mm	up to 355mm	up to 800mm (sizes above 355mm require cooling between welds)	Any size, continuous welding, no cooling
Welds	Any EF fittings	PLASSON only (competitor allowance with App)	Any EF fittings	Any EF fittings
Weld Tip Size	4.0mm Universal	4.0mm Universal	4.0mm Universal	4.0mm Universal
Bluetooth	Y	Y	Y	Y
PLASSON SmartFuse Mode (Automatic)	Y	Y	Y	Y
Manual Input of Welding Time	N	N	Y	Y
Welding Voltage	8-48 V	39.5V	8-48V	8-48V
Output Current (Maximum)	75A (54A)	60A (80A)	80A (110)A	90A (105A)
Data recording	Y	Y with app	Y	Y
Multilingual Display Messages	Y	Y	Y	Y
Error messages in plain text	Y	Y	Y	Y
Adjustable display contrast	Y	Y	Y	Y
Dynamic process supervision	Y	Y	Y	Y
Auto software check	Y	Y	Y	Y
Resistance check	Y	Y	Y	Y
Ramped start	Y	Y	Y	Y
Service Message	After 200 Hours or 12 Months	After 200 Hours or 12 Months	After 200 Hours or 12 Months	After 200 Hours or 12 Months
Barcode reading capability	Y with app	Y with app	Y	Y
Fitting and Operator traceability	Y with app	Y with app	Y	Y
Earth Pin	10A	15A	15A	15A
Active Cooling	N	N	N	Y

\* Detailed Specifications for each model available from PLASSON.

Required Generator Specifications	
Input Voltage Range	190-300V
Frequency	40-70V
Minimum Output	18A at 240V - one phase
Must be able to drive inductive loads	
Must have phase cut control	
Mechanically regulated with brushes is the preferred system	
Synchronized generator	
Minimum	6.5 kVA - Mechanically Controlled 7.5 kVA - Electronically controlled

Minimum Required Generator Output Power 240 V, 50Hz, 1-PHASE.	
Diameter	Output Power
20-75mm	2kW
90-160mm	3.2kW
180-500mm	4.5 kVA - (Mechanically Controlled) 5 kVA - (Electronically Controlled)
≥500mm	6.5 kVA - (Mechanically Controlled) 7.5 kVA - (Electronically Controlled)



## Electrofusion Control Boxes

		Code
POLYCODE	3m Fixed lead	29143.0308S324
Monomatic	5m Lead	29143.0307.000
Polymatic plus USB	5M Lead	29143.0307.103
PolyControl Plus V2	5M Lead	29143.F0318V112



## Welding Cables & Accessories

Welding Cables For Monomatic Or Digimatic Universal	Code
5M Detachable Lead with universal terminals	29142.0610.032
10M Detachable Lead with universal terminals	29142.0611.005

Welding Cables For Polymatic Plus Usb With Universal (Reading Pen Sold Separately)	Code
5M Detachable Lead with 4.0 mm terminals	29142.0610.014
10M Detachable Lead with 4.0 mm terminals	29142.0611.016/1



## Welding Terminal Pin Adaptors

### Smartfuse Adaptors - 29142.0200.006

Extension Key for Tapping Valve	Code
0.8 - 1.1mm	49546010
1.0 - 1.4mm	49546020
1.2 - 1.8m	49546030

Key for Tapping Saddle	Code
18cm	29202000



## Bar Code Readers And Accessories

Reading Pens	Code
Reading Pen 2DL	29142.0100.001
Barcode Scanner Touch ID	29142.0120.004
Barcode Scanner Touch ID for PolyCode	29142.0120.003

Transport Case	Code
Transport Case (Monomatic/ Digimatic/ Polymatic Plus)	29141.2800.005

Ruling And Marking	Code
Magnetic Circular Pipe Ruler	29144.4402.001
Pi-Meter 20-700mm with Vernier 0.1mm	29145.5003.001
Pi-Meter 20-1200mm with Vernier 0.1mm	29145.5003.000

Marking Pens	Code
Marking pens broad white	29145.3100.019



## Pipe Cutting

Secateur Pipe Cutter	Code
Pipe Cutter up to 63mm (Single Hand)	29145.3000.007
Pipe Cutter Spare Blade for 63mm (Single Hand)	29145.3000.008
Pipe Cutter up to 63mm (Two Hand Use)	29145.3000.001

Rotational Pipe Cutter (S-Type)	Code
Rotational Pipe Cutter - 20 - 75mm	29145.3001.004
Rotational Pipe Cutter Spare Blade 20-75mm	29145.3001.005
Rotational Pipe Cutter 50 - 140mm	29145.3001.001
Rotational Pipe Cutter 90 - 160mm	29145.3001.002
Spare Blade 140 / 160mm	29145.3001.003

Rotational Pipe Cutter	Code
Rotational Pipe Cutter 32-125mm	29144.4400.006
Rotational Pipe Cutter 90-315mm	29144.4400.005
Rotational Pipe Cutter 63-225m	29144.4400.004

Rotary Circular Saws 230 V	Code
250-500mm (Max. Cutting Depth 65mm)	29144.4401.002
500-1200mm (Max. Cutting Depth 85mm)	29144.4401.001
180-400 mm (Max. Cutting Depth 38mm)	29144.4401.005



## Pipe Peeling

Hand Scraper	Code
Hand Scraper - Small 1.1/2"	29145.3002.001
Blades for Small Hand Scraper (2)	29145.3002.002
Hand Scraper - Large 2.1/2"	29145.3002.003
Blades for Large Hand Scraper (2)	29145.3002.004



Rotational Peeling Tool Peeling for Saddle and Coupler Installation	Code
Rotational Peeling Tool 16-40mm	29144.4200.000/1
Rotational Peeling Tool 20-63mm	29144.4200.001
Rotational Peeling Tool 20-125mm	29144.4200.031
Rotational Peeling Tool 90-315mm	29144.4200.033
Rotational Peeling Tool 63-225mm	29144.4200.032



U-Peeler Peeling for Saddle and Coupler Installation	Code
U-Peeler 63mm	29144.4800.063
U-Peeler 75mm	29144.4800.075
U-Peeler 90mm	29144.4800.090
U-Peeler 110mm	29144.4800.110
U-Peeler 125mm	29144.4800.125
U-Peeler 140mm	29144.4800.140
U-Peeler 160mm	29144.4800.160
U-Peeler 180mm	29144.4800.180
U-Peeler 200mm	29144.4800.200
U-Peeler 225mm	29144.4800.225



Rotational Pipe End Scraper Tool	Code
Rotational Pipe End Scraper Tool 63-200mm	29144.4200.015
Rotational Pipe End Scraper Tool 90-315mm	29144.4200.027
Rotational Pipe End Scraper Tool 180-400mm	29144.4200.016



Mechanical Rotational End Scraper Tool Battery Powered	Code
PLASSON Scraper Tool For Pipe Ends 25-75mm Incl. Cordless Drill BOSCH in Plastic Suitcase	29144.4200S101



## Pipe Peeling Cont.

Chain Peelers Peeling for Saddle and Coupler Installation	Code
Chain Peeler 250-450mm	29144.4200.007
Chain Peeler 250-800mm	29144.4200.009
Chain Peeler 900-1000mm for Rotational	29144.4200.010
Chain Peeler 400-800mm 230 V	29144.4200.036
Chain Peeler 900-1000mm	29144.4200.038
Chain Peeler 800-1200mm 230 V	29144.4200.037
Extension 1400-1600mm	29144.4200.039

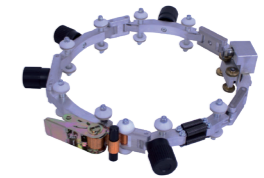

Powered Scrapers	Code
Electrical Saddle Scraper (110V)	29144.4200.025
Electrical Saddle Scraper (230V)	29144.4200.024



Global Presence - Local Commitment

**PLASSON**

## Battery Powered Chain Peeler

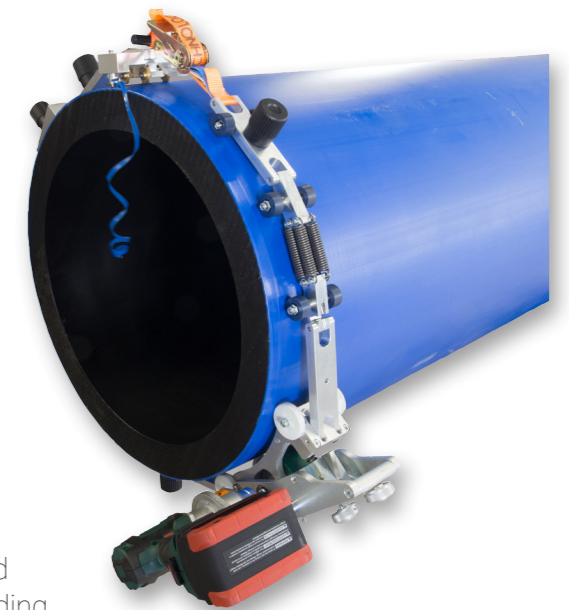

- ✓ Reduce pipe peeling time by almost 75%
- ✓ A new battery powered solution for the fast, more efficient and reliable preparation of large bore PE pipe for electrofusion welding.
- ✓ For use on 400-800mm pipe, with an optional extension kit to 1000mm, the PLASSON replaces hand powered tools to remove the oxidised and contaminated outer layer on PE pipe by peeling a consistent 0.2-0.3mm layer from the pipe surface. A version for pipe 800-1200mm is also available. It can be extended to 1600 mm by the optional extension kit.
- ✓ The chain scraper is designed to work with challenges of ovality, flatness and varying pipe wall thickness, resulting in very large reductions in coupler handling times.
- ✓ Supplied with two quick charge batteries.

## Rerounding Tools | Two required - one rounding tool for each side of fitting.

Rerounding Clamp 32-63mm	Code
32-40mm	29144.4602.006
50-63mm	29144.4602.007

Rerounding Clamp 63-400mm	Code
63-180mm	29144.4602.005
110-250mm	29144.4602.003
180-315mm	29144.4602.004
250-400mm	29144.4602.009

Rounding Pliers 50-63mm	Code
50-63mm	29144.4602.015

Rerounding Rings 63-250mm	Code
63mm	29145.3006.063
75mm	29145.3006.075
90mm	29145.3006.090
110mm	29145.3006.110
125mm	29145.3006.125
140mm	29145.3006.140
160mm	29145.3006.160
180mm	29145.3006.180
200mm	29145.3006.200
225mm	29145.3006.225
250mm	29145.3006.250

Hydraulic Rounding Shell   315-400mm	Code
Hydraulic Jack (315-400)	29145.3008.013
Rounding Shell 315mm (without jack)	29145.3008.001
Rounding Shell 355mm (without jack)	29145.3008.002
Rounding Shell 400mm (without jack)	29145.3008.003

Hydraulic Rounding Shell   450-630mm	Code
Hydraulic Jack (450-630)	29145.3008.014
Rounding Shell 450mm (without jack)	29145.3008.004
Rounding Shell 500mm (without jack)	29145.3008.005
Rounding Shell 560mm (without jack)	29145.3008.006
Rounding Shell 630mm (without jack)	29145.3008.007

Hydraulic Rounding Shell   710-900mm	Code
Hydraulic Jack (710-900)	29145.3008.015
Rounding Shell 710mm (without jack)	29145.3008.008
Rounding Shell 800mm (without jack)	29145.3008.009
Rounding Shell 900mm (without jack)	29145.3008.010

Hydraulic Strap Rounder	Code
450-710mm	29144.4602.017
Extension 800-1200mm	29144.4602.018
450-1200mm	29144.4602.019

\* Hydraulic Tool. Use with PE pipes 450-800mm (Max. SDR 11)

Mechanical Rounding Tool   450-800mm	Code
450-560mm	29144.4602.013
630-710mm	29144.4602.014



Rerounding Shell 315-900mm



Rerounding Shell 315-900mm



Mechanical Rerounding Tool 450-800mm

## Rerounding Tools Cont.

Rerounding Shell 63-225mm	Code
Used to round pipe after squeezing	
63mm	29145.3005.063
75mm	29145.3005.075
90mm	29145.3005.090
110mm	29145.3005.110
125mm	29145.3005.125
140mm	29145.3005.140
160mm	29145.3005.160
180mm	29145.3005.180
200mm	29145.3005.200
225mm	29145.3005.225



## Squeeze Off Tools

Manual Squeeze Off Tool For Gas Pipes	Code
<b>16-32mm</b> (wall 3mm) nad 40mm SDR11	29144.4100.013



Manual Squeeze Off Tool	Code
<b>20-63mm</b> Suits SDR11 16/20,25,32,40,50,63mm & SDR17 63mm Squeeze off is affected by turning the handle in a clockwise direction.	29144.4100.010



Hydraulic Squeeze Off Tool	Code
<b>63-90mm</b> Suits 63-200mm SDR 11 & 17. Sizes: 63,75,90mm. Hydraulic operation. Metric limit plates set at 1.6t. Safety stops to prevent creep. Springs return jack to park position after squeeze off. Integral safety valve.	29144.4100.006

<b>63-180mm</b> Suits 63-180mm SDR 11 & 17. Sizes: 63,75,90,110,125,160,180mm. Hydraulic operation. Metric limit plates set at 1.6t. Safety stops to prevent creep. Springs return jack to park position after squeeze off. Integral safety valve.	29144.4100.005
--	----------------

<b>63-200mm (Excl. 140mm)</b> Suits 63-200mm SDR 11 & 17 (incl. 2 complete stopper sets). Sizes: 63,75,90,110,125,160,180 and 200mm. Hydraulic operation. Metric limit plates set at 1.6t. Safety stops to prevent creep.	29144.4100.011
---	----------------

<b>75-200mm</b> Suits 75-200mm SDR 11 & 17. Sizes: 75,90,110,125,160,180 and 200mm. Hydraulic operation. Metric limit plates set at 1.6t. Safety stops to prevent creep. Springs return jack to park position after squeeze off. Integral safety valve. Springs return jack to park position after squeeze off. Integral safety valve.	29144.4100.007
--	----------------



## Pipe Cleaning

Cleaning Pads	Code
100 cleaning pads with tangit	29145.2000.002

PLASSON Pipewipes ensure surfaces are clean before electrofusion jointing (scraping of pipe surface is still required). 120 sheets per canister.



## Pipe Clamping

Alignment Clamps	Code
<b>Pipe Clamp 16-63mm</b> Adjustable to suit couplers, reducers, 22.5° 45° & 90° elbows and tees. Promotes restraint during the electrofusion process. Infinitely variable grip clamps to suit any combination of sizes, 16-63mm. Quick tightening operation, lightweight & easy to use.	29144.4300.000
<b>Pipe Clamp 32-110mm</b> Adjustable to suit couplers, reducers, 22.5° 45° & 90° elbows and tees. Promotes restraint during the electrofusion process. Infinitely variable grip clamps to suit any combination of sizes, 32-110mm. Quick tightening operation, lightweight & easy to use.	29144.4300.001
<b>Pipe Clamp 63-225mm</b> Adjustable to suit couplers, reducers, 22.5° 45° & 90° elbows and tees. Promotes restraint during the electrofusion process. Infinitely variable grip clamps to suit any combination of sizes, 110-225mm. Quick tightening operation, lightweight & easy to use.	29144.4300.009
Strap Clamps	Code
Used to prevent movement during the weld process. The PLASSON Strap Clamp, a convenient, flexible system for holding PE pipes steady during the electrofusion process. Does not assist with rerounding. For larger dimensions it is recommended to combine two or more Pipe Clamps (Strap Clamp).	
<b>Strap Clamp 110-560mm</b> 4 pipe clamps, 2 base bars, angled adaptor 22.5°, 45°, 90° & 180°	29144.4300.023
<b>Ball Joint</b> Single Ball Joint	29144.4301.001
Double Ball Joint	29144.4301.002
<b>Strap Clamp 250-800mm</b> With 2 fixed clamps, 2 clamps required	29144.4300.021
<b>Strap Clamp 250-800mm Set</b> <b>Included in set:</b> 2 complete clamps each with a pulling clamp, a fixed clamp and pulling shoes for couplers. Allows you to pull the coupler over the pipe and the opposite pipe into the coupler to complete the insertion.	29144.4300.026
<b>Pipe Support</b> Pipe support to 225mm	29144.4601.003



## Specialized Installation Tooling For PLASSON Products

Waste Water Saddle Installation Tools	Code
<b>Waste Water Clamping &amp; Cutting Tool Set 110</b> 110mm X 45Deg fixed outlet saddle clamp kit. Mains pipe sizes DN160-DN315 Includes: - Saddle clamp unit - Coupon removal tool. Drill not included.	29144.4703.001
<b>Tool for Waste Water Saddle 160</b> 160mm Flexible Outlet Saddle Clamp Kit. Main pipe sizes DN225-DN560 Includes: - Saddle clamp unit - Core drill kit	29144.4700.001



Tension belt for Flex Restraint	Code
Flex Restraint installation clamp (160-1200)	29144.4704.002



Clamping Tool For Sensor Adaptor	Code
Clamping Tool For Sensor Adaptor DN110-DN1200	29144.4706K000
Clamping Tool For Sensor Adaptor DN110-DN1200 without starp	29144.4706K001



## Large Bore Saddles Installation Tools

To install a PLASSON Large Bore Saddle the following are required;

- A Clamp Kit to suit the outlet size of the saddle.
- A Strap Kit for outlet sizes DN200 - DN400.
- A Core Cutter to core the saddle after welding.
- A Drill/Motor to operate the Core Cutter.

Clamp Kits - Pipes Dn250-Dn900	Code
<b>Saddle outlet DN90 - DN160 - Includes:</b> <ul style="list-style-type: none"> <li>- Splittable Plates: DN90, 110, 125 &amp; 160</li> <li>- Pressure Test Spigot Removal Tool</li> <li>- Straps</li> <li>- Rounding Ring</li> <li>- Transport Case</li> </ul>	29144.4701.003
<b>Saddle outlet DN200/DN180 - Includes:</b> <ul style="list-style-type: none"> <li>- Splittable Plate: DN200/DN180</li> <li>- Rounding Ring</li> <li>- Transport Case</li> <li>- Strap kit required</li> </ul>	29144.4701.201
<b>Saddle outlet DN225/DN250 - Includes:</b> <ul style="list-style-type: none"> <li>- Splittable Plate: DN250</li> <li>- Rounding Ring</li> <li>- Transport Case</li> <li>- Strap kit required</li> <li>- Rerounding adaptor required for DN225 2012043</li> </ul>	29144.4701.251
<b>Saddle outlet DN 315/DN 280 - Includes:</b> <ul style="list-style-type: none"> <li>- Splittable Plate: DN 315/DN 280</li> <li>- Transport Case</li> <li>- Strap kit required</li> <li>- Pressing plate</li> </ul>	29144.4701.315
<b>Saddle outlet DN 400/DN355 - Includes:</b> <ul style="list-style-type: none"> <li>- Splittable Plate: DN 400/DN355</li> <li>- Transport Case</li> <li>- Strap kit required</li> <li>- pressing plate</li> </ul>	29144.4701.400
Strap Kit	Code
<b>Straps for clamping all Clamp Kits DN200-DN900</b> Includes: <ul style="list-style-type: none"> <li>- 3x Straps</li> <li>- 3x Ratchets</li> <li>- Torque wrench</li> <li>- Pressure Test Spigot Removal Tool</li> <li>- Transport Case</li> </ul>	29144.4701.009
Rounding Adaptor	Code
DN250 to DN225 Rerounding Adaptor - Use with clamp kit	29141.4701.058
Support Bar	Code
Support Bar for Large Bore Repair Saddle DN250 – DN900 Use in conjunction with DN160 Saddle Outlet Kit	29142.4701.071
Saddle Pressing Tool	Code
Pressing Tool 225mm/SDR17 for lightFit Saddle	29142.4701.066
Saddle Clamping Tool	Code
Clamping Plate 225mm/SDR17 Splittable, for LightFit Saddle	29142.4701.226



## Large Bore Saddles Installation Tools Cont.

Core Cutters	Code
<b>Saddle outlet DN90 - DN160 - Includes:</b> <ul style="list-style-type: none"> <li>1x 2"</li> <li>1x DN90 core cutter</li> <li>1x DN110 core cutter</li> <li>1x DN125 core cutter</li> <li>1x DN160 core cutter</li> <li>1x Centre Drill</li> <li>1x Drill chuck connector</li> <li>1x Connector for SDS-Plus</li> <li>1x Transport Case</li> </ul>	29144.4702.003
<b>Saddle outlet DN180, SDR11</b> DN180 Core Cutter, Borehole 143mm Includes Drill Adaptor and Case	29144.4702.143
<b>Saddle outlet DN200, SDR11</b> DN200 Core Cutter, Borehole 159mm Includes Drill Adaptor and Case	29144.4702.159
<b>Saddle outlet DN225, SDR11</b> DN225 Core Cutter, Borehole 179mm Includes Drill Adaptor and Case	29144.4702.179
<b>Saddle outlet DN250, SDR11</b> DN250 Core Cutter, Borehole 199mm Includes Drill Adaptor and Case	29144.4702.199
<b>Saddle outlet DN315, SDR11</b> DN315 Core Cutter, Borehole 251mm Includes Drill Adaptor and Case	29144.4702.251
<b>Saddle outlet DN355, SDR11</b> DN355 Core Cutter, Borehole 283mm Includes Drill Adaptor and Case	29144.4702.283
<b>Saddle outlet DN400, SDR11</b> DN400 Core Cutter, Borehole 319mm Includes Drill Adaptor and Case	29144.4702.319



Pressure Test Pump	Code
<b>Pressure test pump</b> with adapter for PLASSON large bore saddles	29144.4701.005

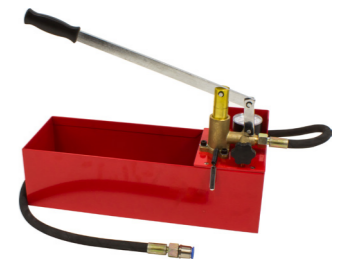

## Tools for Drilling

Saddles with outlets DN90 – DN225 use a hand operated drill.  
 Saddles with a DN250 outlet can use either a hand operated drill or a motor mounting clamp and motor.  
 Saddles with outlets DN315 - DN400 use a motor mounting clamp and motor.  
 The same motor can be used on all outlets.

Drills - Motor	Code
DN90 - DN250 Outlets. BE75-X3 Quick	29144.4702.999

Saddle Drilling Equipment	Code
---------------------------	------

A complete tool consists of: Basic kit, clamping ring and core cutter.  
 So, the user must choose the components he needs when he orders.

Basic Kit	29144.4702.911
Core cutter 250mm	29142.4702.030
Core cutter 280mm	29142.4702.035
Core cutter 315mm	29142.4702.029
Core cutter 355mm	29142.4702.034
Core cutter 400mm	29142.4702.028



## Hot Tapping Tool

Hot Tapping	Code
Core cutter 250mm	29142.4702.030
Core cutter 280mm	29142.4702.035
Core cutter 315mm	29142.4702.029
Core cutter 355mm	29142.4702.034
Core cutter 400mm	29142.4702.028
Hot Tapping Tool ISO Flange DN150 with 230V Motor	29144.4705.001
Hot Tapping Tool ISO Flange DN150 with 110V Motor	29144.4705.002
Hot Tapping Tool ISO Flange DN150 with 230V Hydraulic Motor excluding hydraulic pump	29144.4705.H001
Hydraulic Pump with Gasoline Engine	29142.4705.300

The tools consists of Motor, Pressure compartment, an Adapter (if necessary) and a core cutter. All components must be ordered separately:

PN16 Compartment DN150	29142.4705.001
PN16 Compartment DN200	29142.4705.006
PN16 Compartment DN250	29142.4705.002
PN16 Compartment DN300	29142.4705.007
PN16 Compartment DN400	29142.4705.004
Adapter DN150 -> DN100	29142.4705.100
Adapter DN150 -> DN80	29142.4705.101



# Hot Tapping Tool for Large Bore Saddles

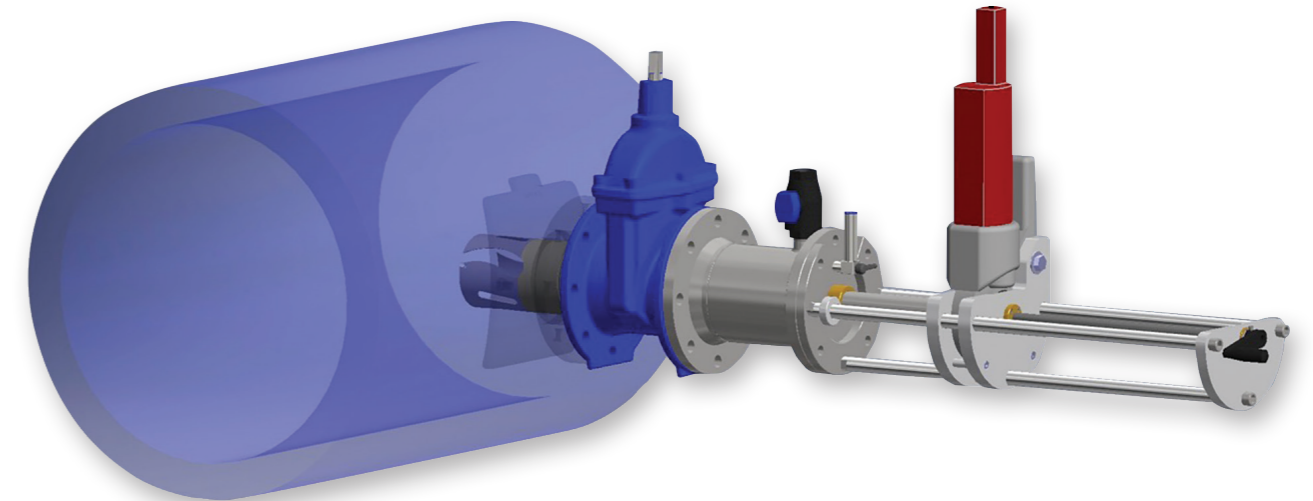

Contact PLASSON for more information



## Take good care of your PLASSON control box



It is recommended that control boxes are serviced every 12 months or 200 hours of operation

Frequent servicing of your control box reduces the risk of operational problems interrupting the work flow and costing you money.

**A standard service includes:**

- Recalibration
- Installation of latest software
- Inspection and testing of all components
- Calibration Certificate

E-mail: [sales@plasson.com](mailto:sales@plasson.com) [www.flowsolutions.plasson.com](http://www.flowsolutions.plasson.com)

