

 **PLASSON**[®]

Plasson ElectroFusion Wastewater System



Innovative Technology for Laying New Pipe Networks and Renovating Existing Piping Systems

2013



Global Presence - Local Commitment

 **PLASSON**[®]

Plasson® ElectroFusion Wastewater System

We Make the Connection

Plasson has been at your side for almost 50 years – your expert partner and supplier in the gas and water industries.

Plasson Wastewater Fittings (unless otherwise indicated) are for non pressurized systems, up to 0.5 bar. The PE 80 and PE 100 system is the result of many years experience and understanding of requirements in the field.

Plasson Wastewater System is “completely watertight” – the proven ElectroFusion technology not only provides a long-term seal, but also offers fully computerized control and monitoring during the laying of new piping or the renovation of existing networks.



The LightFit Coupler, a part of the Wastewater System in conjunction with a Manhole Adaptor.



The Wastewater Saddle, with 160mm inlet Adjustable Coupler, offering an adjustable angled connection of up to 12°.



The Wastewater Saddle with 110mm 45° Inlet, offering an angled connection.

Polyethylene offers the ideal cost-effective and technically superior alternative to other materials, requiring minimal effort to install, reducing the number of connections required and increasing the system’s lifespan.

The Plasson System provides an excellent investment for both public water infrastructures and private wastewater systems.



The Plasson Wastewater System provides a strong, long-life and axially load resistant solution through its special versatile products that can be completely fused after being laid.

LightFit Coupler (PN10)

460104

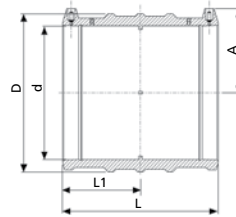

Size d	L	L1	D	A	W	UC
40	90	43	56	47	96	200
50	100	49	68	52	98	132
63	118	57	77	57	98	112
75	126	61	90	63	214	60
90	148	72	108	69	360	44
110	163	80	131	79	540	25
125	173	85	149	87	740	20
140	182	89	167	94	970	12
160	198	97	193	104	1320	6
180	212	104	215	114	1650	5
200	232	114	235	127	2100	4
225	240	118	264	141	2825	4
250	256	126	293	155	3728	2
280	275	135	332	166	4850	1
315	284	140	374	184	6950	1
355	280	138	421	204	7980	1
400	296	146	474	227	11893	1

460103

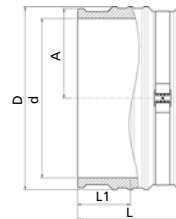

Size d	L	L1	D	A	W	UC*
450	310	155	518	255	11700	5
500	340	170	576	283	16000	5
560	376	188	645	317	21500	5
630	418	209	726	356	30820	4
710	472	236	817	400	43100	4
800	500	250	913	450	57300	4

* Optimal order quantity for packing on two stacked pallets

Wastewater Adjustable Saddle

475804



For optimal flexibility, the Wastewater ElectroFusion Saddle includes a connecting Coupler that can be adjusted to an angle of up to 12°.

The final position is permanently fixed only at the ElectroFusion welding stage.

To be used with pipes SDR 11 to SDR 26

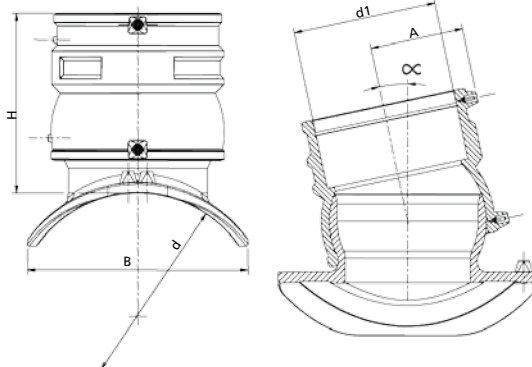

Size d x d1	B	H	A	L	W	UC
200 x 160	208	202	105	Max. 12°	2050	4
225 - 250 x 160	225	202	105	Max. 12°	2010	4
280 - 315 x 160	247	202	105	Max. 12°	2070	4
355 - 560 x 160	263	202	105	Max. 12°	2080	4

to be installed by using Plasson drilling and clamping tool cat. no. 29144.4700.001

Wastewater Saddle 45° - Inlet 110

4758A4



The Plasson Wastewater Saddle 45° Inlet -110 mm enables a 45° connection of the supply pipe. Special tools are used to ensure a full bore hole and a permanent ElectroFusion weld.

To be used with pipes SDR 11 to SDR 26

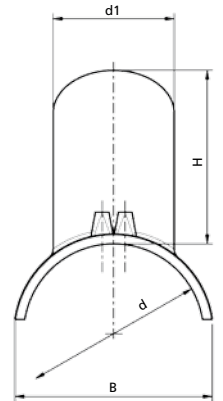
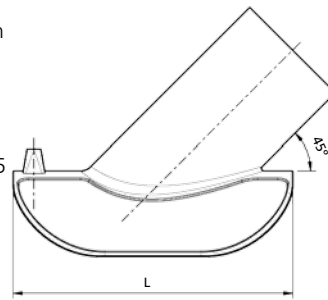

Size d x d1	L	B	H	W	UC
160 - 200 x 110	255	182	158	685	10
225 - 315 x 110	255	221	158	710	10

to be installed by using Plasson cutting and clamping tool cat. no.29070050

Wastewater Saddle PVC/PP Adaptor Inlet

4758V4

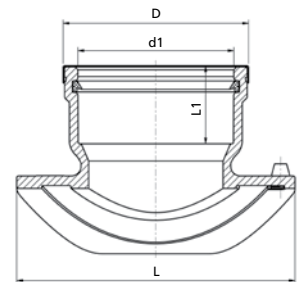
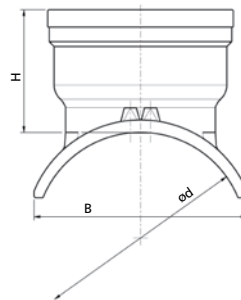

Size d x d1	B	H	L	L1	D	W	UC
200 x 160	208	125	290	80	190	1660	4
225 - 250 x 160	225	125	290	80	190	1309	4
280 - 315 x 160	247	125	290	80	190	1326	4
355 - 560 x 160	263	125	290	80	190	1430	4

to be installed by using Plasson drilling and clamping tool cat. no. 29144.4700.001

Wastewater Saddle Spigot Inlet

4758S4

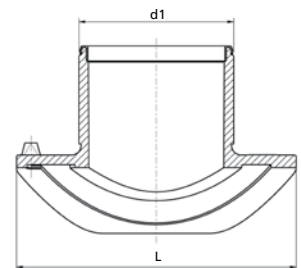
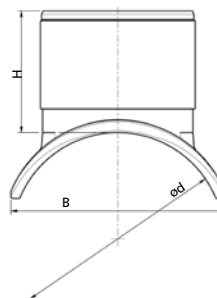

Size d x d1	B	H	L	W	UC
200 X 160	208	125	290	1091	4
225 - 250 x 160	225	125	290	1239	4
280 - 315 x 160	247	125	290	1260	4
355 - 560 x 160	263	125	290	1300	4

to be installed by using Plasson drilling and clamping tool cat. no. 29144.4700.001.001

Wastewater Adjustable Elbow One Sided

4747D4



The Wastewater Adjustable Elbow, offers additional flexibility during installation, allowing an adjustable angled connection of up to 12°. The supply pipe can therefore be precisely adjusted without stress to fit the site conditions. After positioning, the connection is permanently fixed at the ElectroFusion welding stage.

To be used with pipes SDR 11 to SDR 26

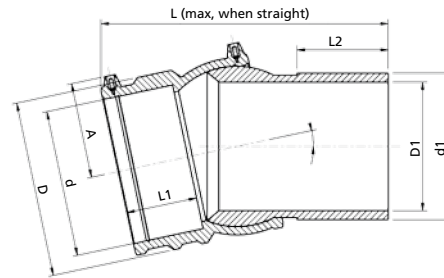

Size d	SDR	D	D1	L	L1	L2	A	W	UC
160	17	193	141	298	78	98	105	3030	6

Wastewater Manhole Adaptor

37020/477207*

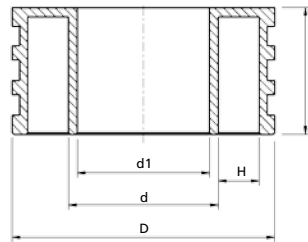

Size d	L	d1	D	H	W	UC
110	135	97	216	37	1650	-
125	135	111	235	39	1800	-
140	135	123	254	39	1950	-
160*	135	141	280	39	2524	6
180	135	157	335	66	3550	4
200	135	176	355	56	3660	2
225*	135	198	355	44	3902	2
250	135	220	400	54	3740	2
280*	135	247	400	39	5027	2
315	135	278	450	46	5130	2
355	135	313	500	50	6480	2
400	135	353	560	59	8260	1
450	135	397	592	50	22350	-
500	135	441	651	54	23600	-
560	135	494	705	51	34500	-

Wastewater PE to PVC Adaptor

4701V4

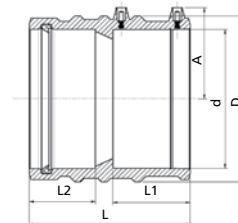

Size d	L	L1	L2	D	A	W	UC
160	187	90	77	193	106	-	-

Wastewater Adjustable Elbow PE to PVC

4747V4

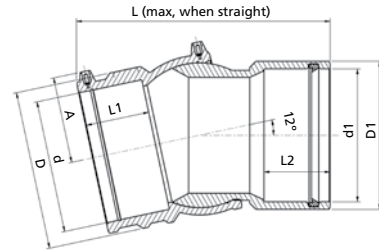

Size d x d1	D	D1	L	L1	L2	A	W	UC
160 X 160	193	180	253	78	80	105	2140	-

Wastewater Adaptor for Clay Pipe

37980

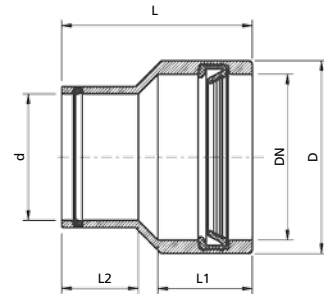

Size d x DN	D	L	L1	L2	W	UC
160 X 186	227	236	121	98	1072	-
160 X 204	249	245	121	98	1087	-

Wastewater Spigot Adaptor for Clay Pipe

37117

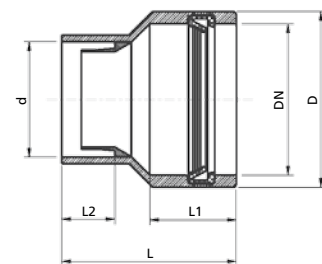

Size d x DN	D	L	L1	L2	W	UC
160 X 186	227	248	121	74	1067	-
160 X 204	249	248	121	74	1085	-

Wastewater Elbow 45°

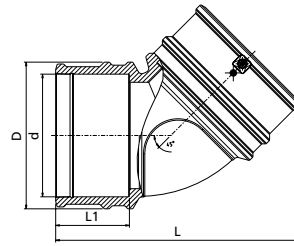

470604

Size d	L	L1	D	A	W	UC
160	325	98	193	106	2000	-

Wastewater Elbow 30°

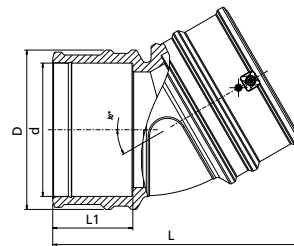

473304

Size d	L	L1	D	A	W	UC
160	302	98	193	106	1850	-

Wastewater Elbow 15°

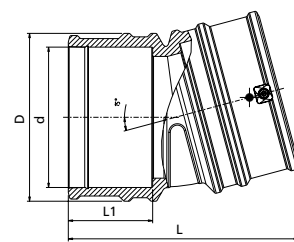

473704

Size d	L	L1	D	A	W	UC
160	267	98	193	106	1740	-

Tools for Wastewater Saddles

29144.4700.001 Drilling And Clamping Tools (set) for Wastewater Branch Saddle 160 mm



29070050 Cutting and Clamping Tools for 45° Wastewater Saddle 110Mm

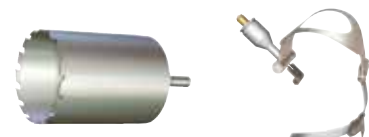



Global
Presence
Local
Commitment

 **PLASSON**[®]

PLASSON Ltd.

Maagan Michael

D.N. Menashe 37805 Israel

Tel: +972-4-6394711

Fax: +972-4-6390887

E-mail: sales@plasson.com

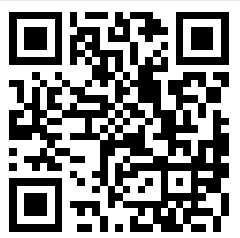

www.plasson.com